

STEP MOTORS

*Superior
Electric*

www.DanaherMotion.com

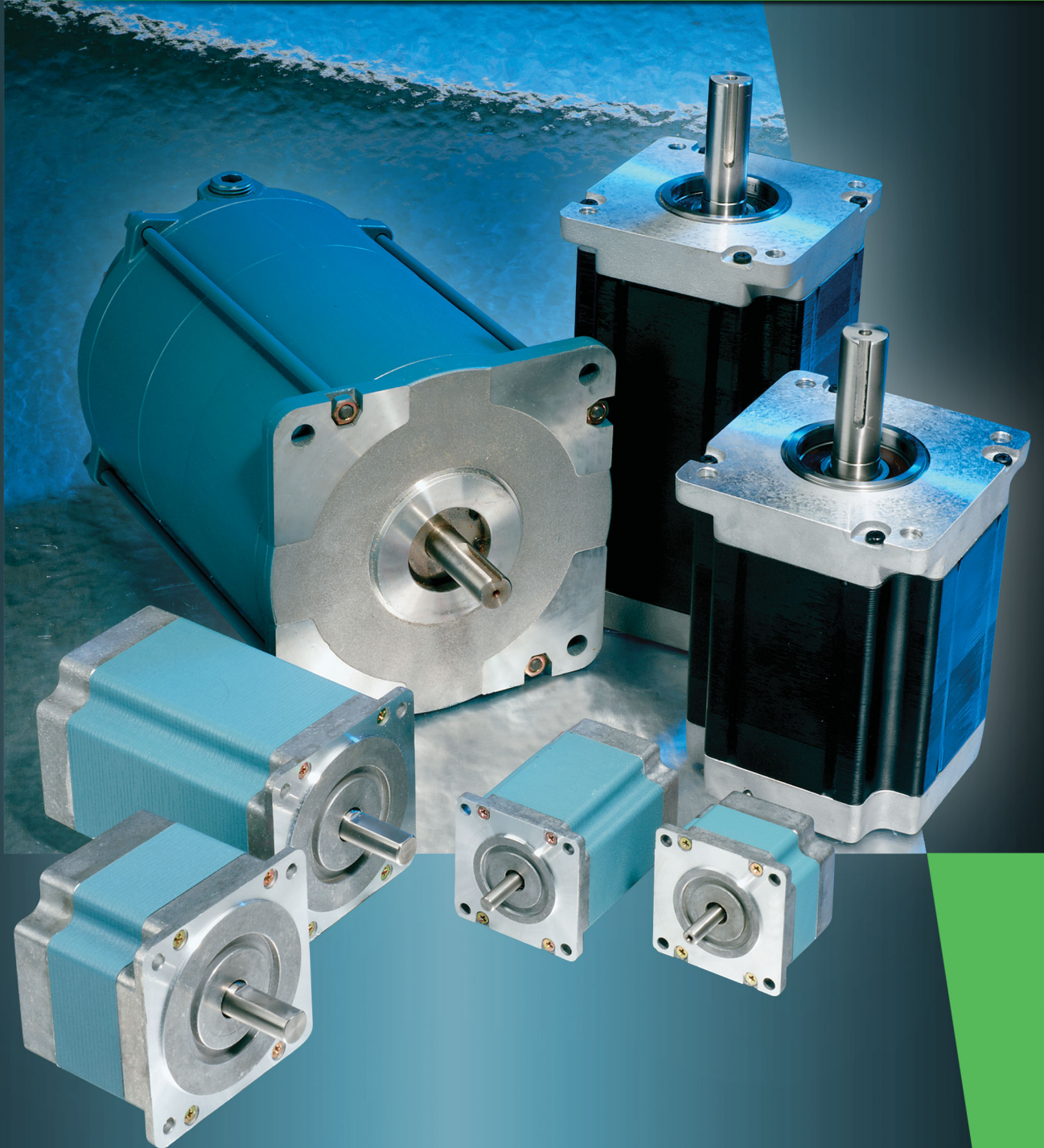

Danaher Motion and Superior Electric

Superior Electric is a Danaher Motion brand, and is recognized worldwide as the leading manufacturer of step motor positioning systems. Over 40 years ago, Superior Electric developed and patented their Superior step motor products.

The Superior Electric family of automation products includes:

- Step Motors
- Step Motor Drives
- Motion Controls
- Synchronous Motors

This catalog highlights the latest selection of high torque step motors from Superior Electric. Our new line of NEMA size 42 high torque motors complements and extends the range of our size 23 and 34 high torque motors. These high torque motors provide world-class performance, and represent the best value ever offered by Superior Electric. They provide twice the torque (and in some cases more than twice the torque) of older conventional step motors.

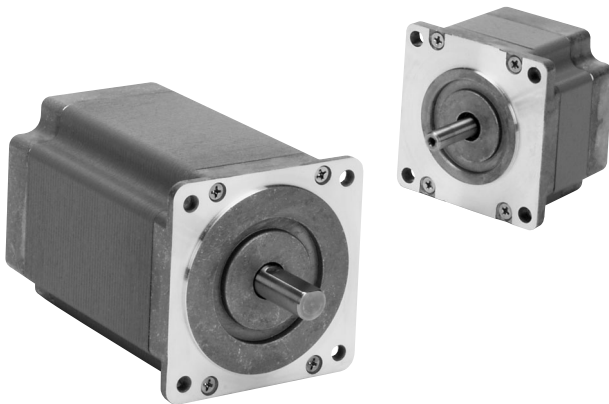

Your partner in Motion Control

Danaher Motion has extensive experience customizing motors to meet our customer's specific design requirements. Our engineering staff will work with you to achieve your product performance goals. We provide motion control solutions for a wide variety markets and applications including:

- Semiconductor manufacturing
- Packaging
- Printing
- Industrial Automation
- Testing and measurement

Flexible manufacturing capabilities enable us to deliver specialized product quickly – helping you meet your development cycle objectives.

Danaher Motion offers a comprehensive line of motors, drives, controls, and actuators designed to optimize the performance of motion control systems. These address a wide array of requirements, ranging from simple repetitive moves to complex multi-axis motion. On-going product development enables Danaher Motion to provide innovative, leading edge solutions to our customers.

One of the best reasons to select a Superior Electric product is Danaher Motion's superior service and support. Our products are available globally through the industry's most extensive and experienced distributor network. These trained distributors provide valuable technical assistance, in addition to fast delivery and service. A team of application engineers backs our distributor network. The combined experience of this support system ensures that our customers receive prompt, quality attention to their needs, no matter where they are located.

Further assistance and support is provided on the web at www.DanaherMotion.com. Visitors to this site will find product information, technical specifications, and information on our distribution network. In addition, MOTIONEERING® Motor Selection Software is available as a free download. This Windows® based program makes it easy to select the best stepper system for an application.

Table of Contents

Introduction to Step Motors	4
Typical Applications	4
Features of a High Torque Step Motor	4
Sizing and Selection Software	4
Quick Selection Guide	5
KM06 Series - NEMA 23	6-9
KM09 Series - NEMA 34	10-13
KM11 Series - NEMA 42	14-17
MH172 Series - NEMA 66	18-19
MX09 Series - NEMA 34 Hazardous Duty Motors	20
MX11 Series - NEMA 42 Hazardous Duty Motors	21
Encoders	22-23
MOTIONEERING® Application Software	24
Application Assistance	24-28
Technical Notes	29-31
Connection Diagrams	31
Options and Modifications	32
Definitions	33-35

How To Use This Catalog



The quick selection guide on page 5 gives an overview of the entire product offering. Sections for each frame size are in order of increasing motor frame sizes. Each frame size section includes detailed motor specifications and speed torque curves of motor / drive system combinations. For easy comparison, the speed torque curves are arranged by drive voltage and motor length.

Hazardous duty motors, add on options, and overall technical information are towards the back of the catalog.

The table of contents at the left will help you find more information on each of our products.

Additional information on all our products can be found by visiting our website at:
www.DanaherMotion.com

Introduction To Step Motors

Superior Electric step motors provide very precise, cost effective, motion control.

Superior step motors inherently move in small, very precise, 1.8° increments (200 / revolution). This stepping action is simple to control and does not require complicated, expensive feedback devices. With micro-stepping drives, each 1.8° step can be broken into even smaller increments. And, if position verification is required, motors are available with encoders.

Due to their ease of use, simplified control needs and freedom from expensive feedback requirements, Superior step motors are excellent alternatives to pneumatic, hydraulic and servo motor systems.

Typical Applications

- Automation and inspection
- Conveyor transfer
- Cut-to-length metal, plastic, fabric, etc.
- Industrial HVAC
- Material handling
- Medical equipment
- Office peripheral equipment
- Packaging systems
- Pick-and-place applications
- Printing systems
- Robotics
- Semiconductor manufacturing

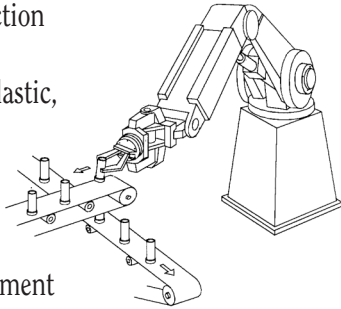

High Torque Motor Construction

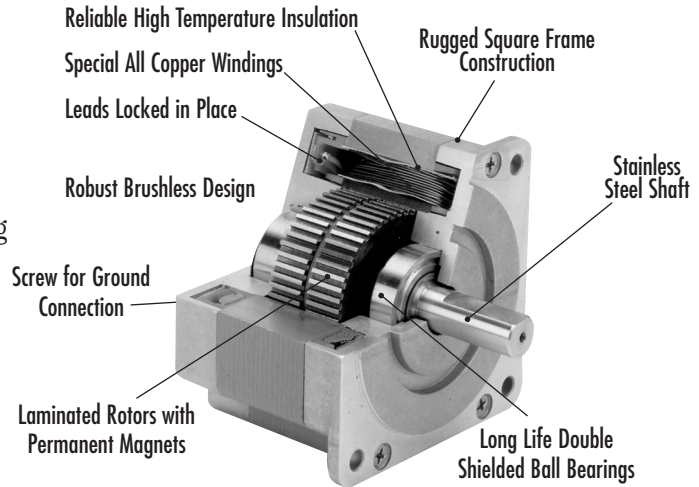

Sizing and Selection Software for Superior Electric Products

Step motor systems are often used in high performance positioning systems. The correct motor and drive are equally important for the system to meet performance and cost goals. To select a motor and drive for a given situation requires an analysis of the load, mechanical system and desired cycle times or speeds.

MOTIONEERING® Software for Superior Electric, makes the selection process easy.

MOTIONEERING® is a menu driven, Windows®-based program that automatically takes into account load, motor and drive parameters. A wide variety of mechanisms are accommodated including: lead screw, rack and pinion, conveyor (belt and pulley), nip rolls, and rotary, as well as direct data entry.



MOTIONEERING® provides a versatile environment for choosing the optimum system for your application, and is available free of charge.

Quick Selection Guide

NEMA Frame	Page #	Model	Holding Torque oz-in (N-cm)	Rotor Inertia oz-in-s ² (kg-cm ²)	Relative Torque
23	6-9	KM060	68 (48)	0.00154 (0.108)	
		KM061	170 (120)	0.0034 (0.24)	
		KM062	250 (177)	0.0056 (0.395)	
		KM063	350 (247)	0.0084 (0.593)	
34	10-13	KM091	385 (272)	0.016 (1.13)	
		KM092	770 (544)	0.031 (2.19)	
		KM093	1,155 (816)	0.047 (3.32)	
42	14-17	KM111	1,450 (1,020)	0.078 (5.5)	
		KM112	2,750 (1,940)	0.155 (10.9)	
		KM113	3,750 (2,650)	0.229 (16.2)	
66	18-19	MH172	5,330 (3,764)	0.870 (61.4)	

Holding Torque

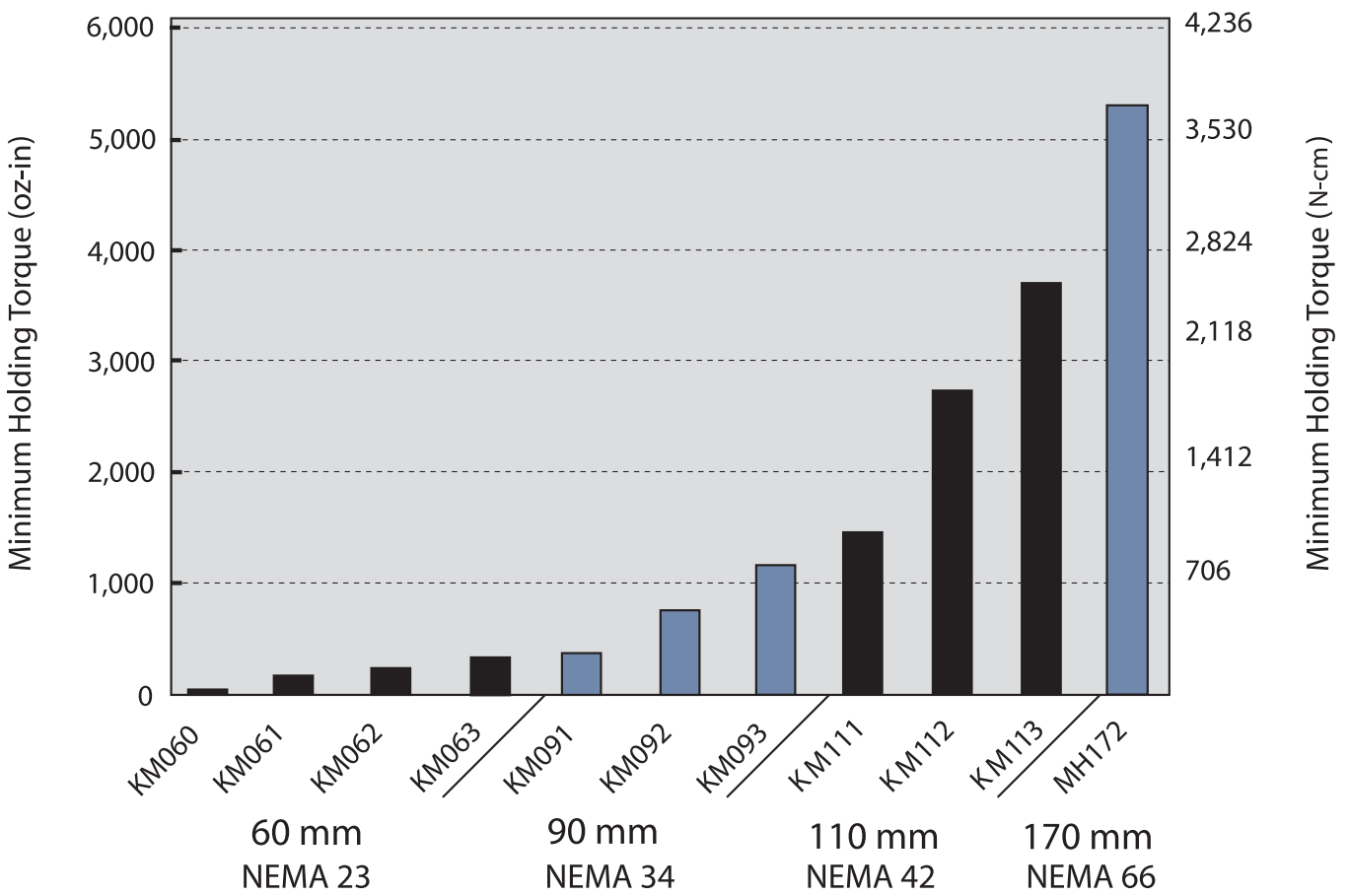

www.DanaherMotion.com • 704-588-5693

KM06

High Torque 60mm Frame Size (NEMA Size 23)

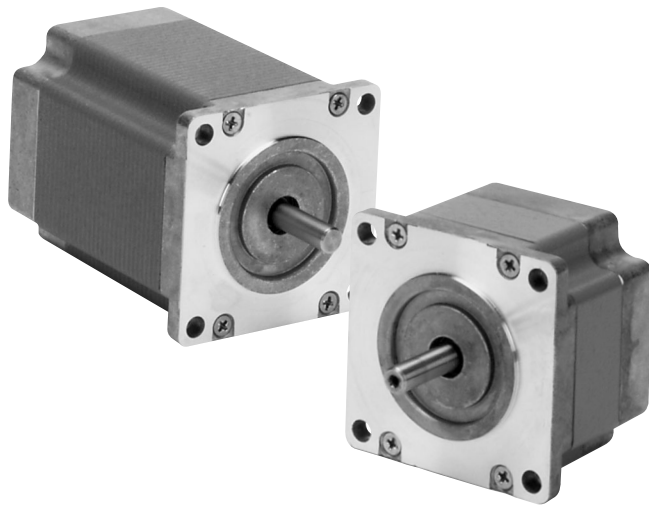

Performance Envelope

(see page 9 for detailed torque-speed curves)

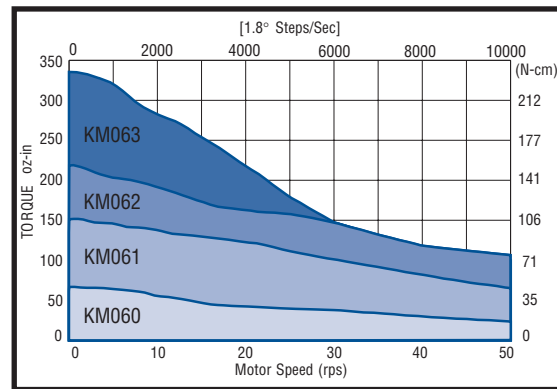

- Up to 200% rated torque reserve capacity
- ± 2% typical step accuracy
- Terminal box, encoders, precision gearheads and rear shafts available
- Available with four or six leads
- Customized configurations available



Motor Frame	Minimum Holding Torque		Rotor Inertia oz-in-s ² (kg-cm ²)	*Weight		Maximum Shaft Load		Minimum Residual Torque oz-in (N-cm)
	Unipolar 2Ø on	Bipolar 2Ø on		Net	Ship	Overhang	Thrust	
	oz-in (N-cm)	oz-in (N-cm)		lb (kg)	lb (kg)	lb (kg)	lb (kg)	
KM060	54 (38)	68 (48)	0.00154 (0.108)	1.03 (0.47)	1.1 (0.050)	15 (6.8)	25 (11)	2.0 (1.4)
KM061	128 (90.4)	170 (120)	0.0034 (0.24)	1.6 (0.73)	1.7 (0.77)	15 (6.8)	25 (11)	3.0 (2.1)
KM062	188 (133)	250 (177)	0.0056 (0.395)	2.3 (1.04)	2.5 (1.1)	15 (6.8)	25 (11)	6.0 (4.2)
KM063	263 (186)	350 (247)	0.0084 (0.593)	3.2 (1.45)	3.4 (1.5)	15 (6.8)	25 (11)	7.0 (4.9)

* Weight for motor with leads (add approximately 0.2 lbs for terminal box).

KM06

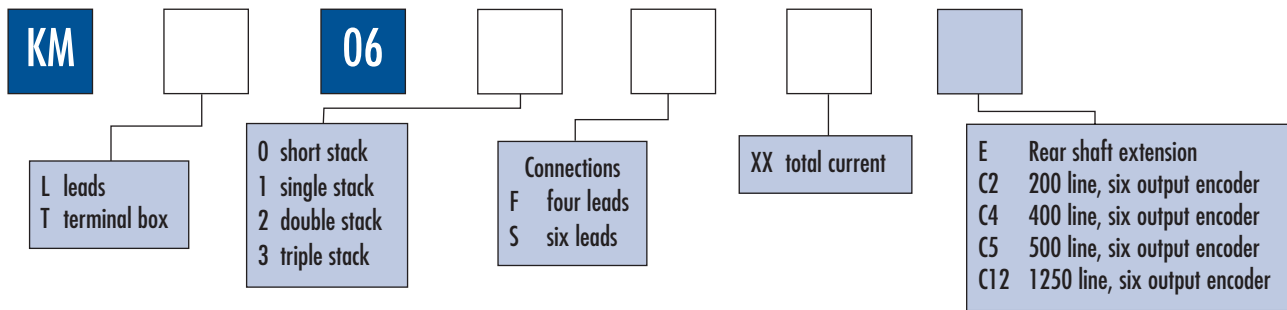

See next page for additional KM06 information

4-CONNECTION STEP MOTORS				
Model Number	Winding Specifications			
	Voltage (VDC)	Current (amperes)	Resistance (ohms)	Inductance (mH)
See Next page for options				
KM□060F02	3.8	1.1	3.6	16
KM□060F05	1.7	2.7	0.64	2.5
KM□060F08	1.1	4.0	0.28	1.0
KM□060F11	1.0	5.3	0.19	0.63
KM□061F02	5.2	1.1	4.9	30
KM□061F03	4.2	1.4	3.0	16
KM□061F05	2.3	2.7	0.85	4.6
KM□061F08	1.4	4.1	0.33	1.8
KM□061F11	1.2	5.4	0.23	1.1
KM□062F03	4.4	1.5	2.9	17
KM□062F05	3.1	2.5	1.3	7.1
KM□062F07	2.5	3.3	0.75	3.4
KM□062F08	2.0	4.1	0.49	2.5
KM□062F13	1.3	6.6	0.20	0.85
KM□063F03	6.1	1.5	4.1	24
KM□063F04	5.0	1.8	2.8	17
KM□063F07	3.4	3.3	1.0	6.2
KM□063F08	2.6	4.1	0.64	3.9
KM□063F13	1.9	6.6	0.28	1.5

6-CONNECTION STEP MOTORS								
Model Number	Winding Specifications							
	Unipolar				Bipolar Series			
	Voltage (VDC)	Current (amperes)	Resistance (ohms)	Inductance (mH)	Voltage (VDC)	Current (amperes)	Resistance (ohms)	Inductance (mH)
See Next page for options								
KM□060S03	2.9	1.5	1.9	4.0	4.0	1.0	3.9	16
KM□060S08	1.3	3.8	0.34	0.63	1.8	2.7	0.67	2.5
KM□061S02	6.4	1.0	6.4	18	9.0	0.70	13	70
KM□061S04	3.0	2.1	1.5	3.5	4.2	1.4	2.9	14
KM□061S08	1.7	3.8	0.46	1.1	2.4	2.7	0.92	4.4
KM□062S04	3.1	2.1	1.5	4.2	4.4	1.5	2.9	17
KM□062S06	2.8	3.0	0.94	2.5	3.9	2.1	1.9	10
KM□062S09	1.8	4.7	0.38	0.85	2.5	3.3	0.75	3.4
KM□063S04	4.3	2.1	2.0	6.0	6.0	1.5	4.0	24
KM□063S09	2.5	4.7	0.54	1.6	3.5	3.3	1.1	6.3

KM06: Motor Dimensions

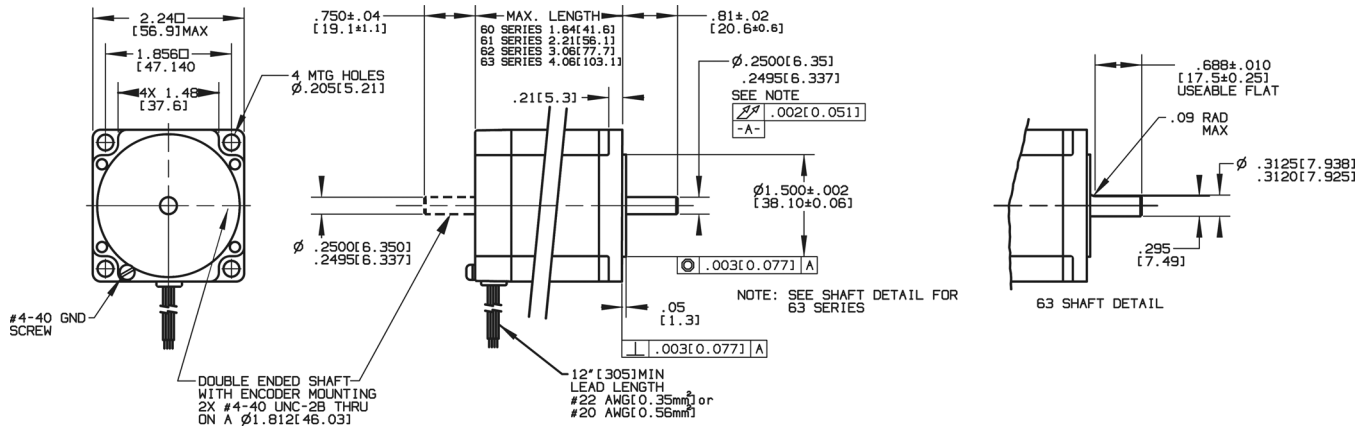

Add "E" to model number for double ended shaft. Example: M062-LS03E

Encoder

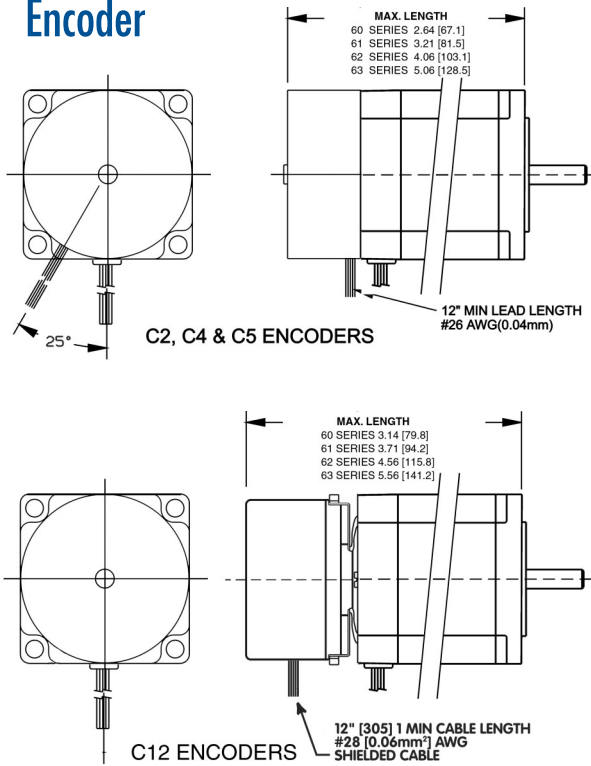

Add to Model Number:

- C2 200 lines per rev.
- C4 400 lines per rev.
- C5 500 lines per rev.
- C12 1250 lines per rev.

Outputs: A, B, Index,
A, B, Index,

Differential Line Drivers supplied

Example: KML063S09C5

For encoder specifications see pages 22-23

Terminal Box

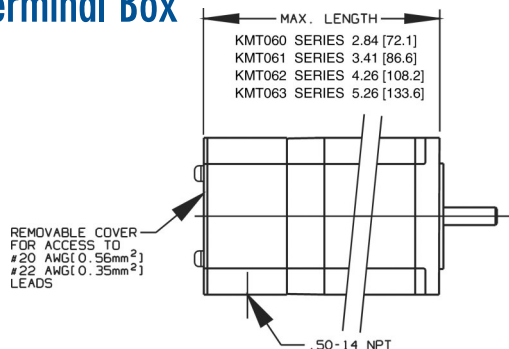

Change to Model Number:

Example: KMT063S09 (triple stack, terminal box, six leads, 4.7 amp winding)

KM06

24 V Bipolar - Full Step

24 volt data measured with SS2000MD4 drive.

KM060

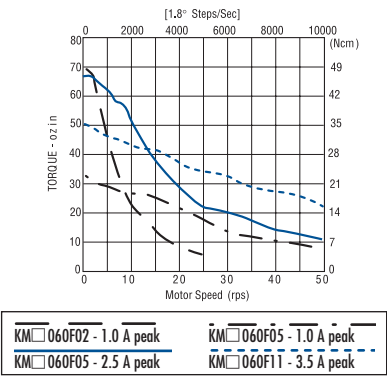

36 V Bipolar - Full Step

36 volt data measured with SS2000MD4 drive.



72 V Bipolar - Microstep

72 volt data measured with MD808 drive

- The curves do not show system resonances which will vary with system mechanical parameters.
- Duty cycle is dependent on torque, speed, drive parameters, and heat sink conditions. Maximum case temperature is 100°C.

KM061

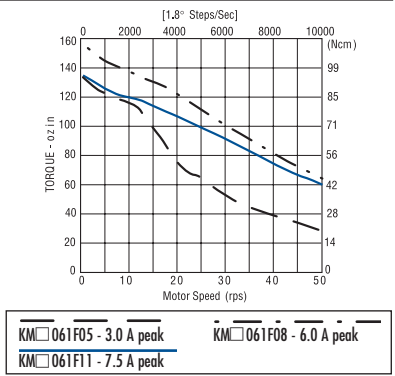
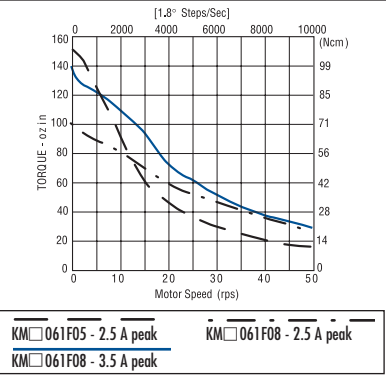
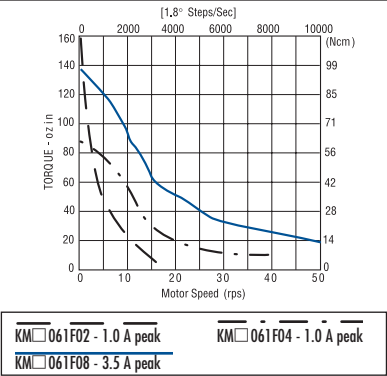

KM062

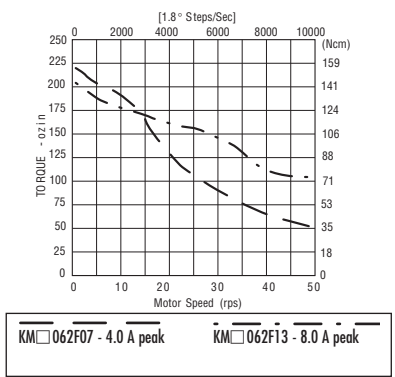
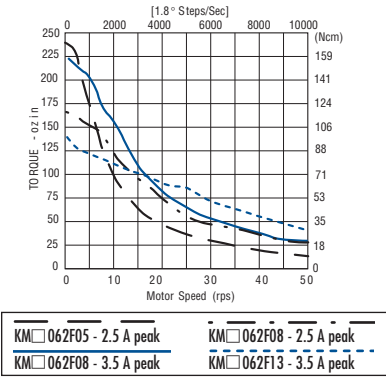
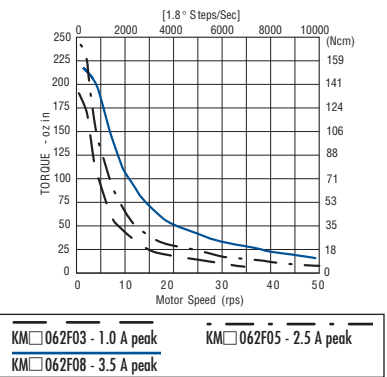

KM063

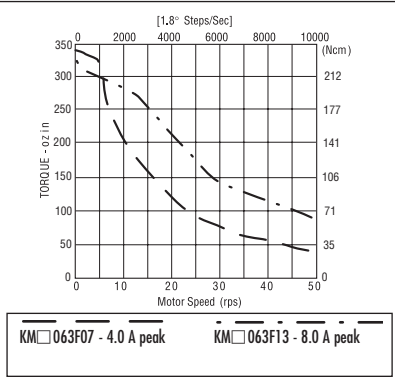
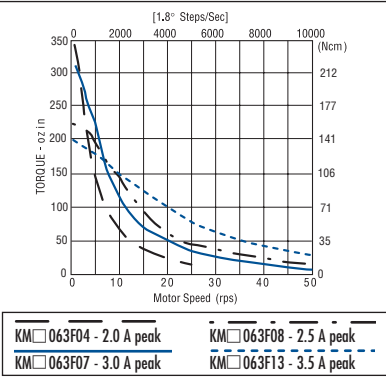
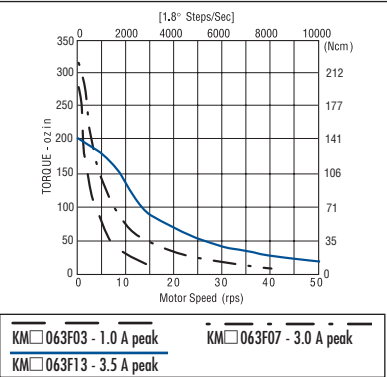

KM09

High Torque 90mm Frame Size (NEMA Size 34)

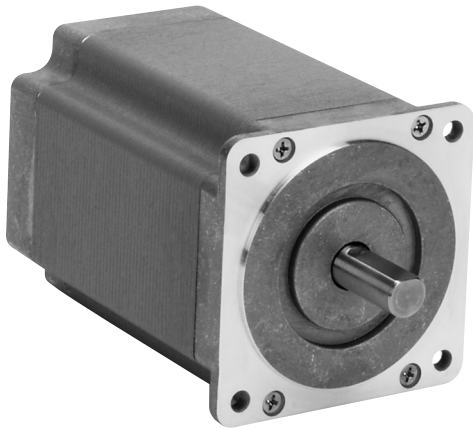

Performance Envelope

(see page 13 for detailed torque-speed curves)

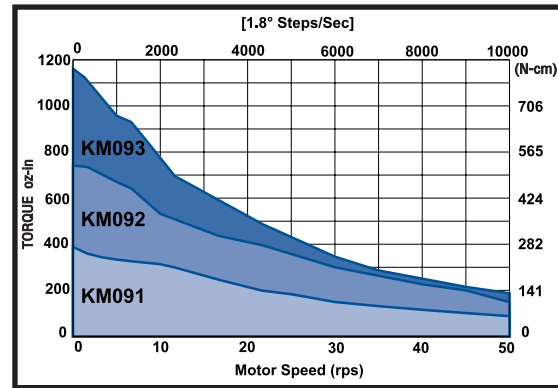

- Up to 200% rated torque reserve capacity
- ± 2% typical step accuracy
- Standard terminal box, encoders, and precision gearheads available
- Available with four or six leads
- Customized configurations available



Motor Frame	Minimum Holding Torque		Rotor Inertia oz-in-s ² (kg-cm ²)	*Weight		Maximum Shaft Load		Minimum Residual Torque oz-in (N-cm)
	Unipolar 2Ø on	Bipolar 2Ø on		Net	Ship	Overhang	Thrust	
	oz-in (N-cm)	oz-in (N-cm)		lb (kg)	lb (kg)	lb (kg)	lb (kg)	
KM091	305 (215)	385 (272)	.016 (1.13)	3.8 (1.73)	4.0 (1.81)	25 (11)	50 (23)	10 (7.1)
KM092	610 (431)	770 (544)	.031 (2.19)	6.2 (2.82)	6.4 (2.90)	25 (11)	50 (23)	15 (11)
KM093	915 (646)	1155 (816)	.047 (3.32)	8.7 (3.95)	8.9 (4.03)	25 (11)	50 (23)	23 (16)

* Weight for motor with leads.

KM09

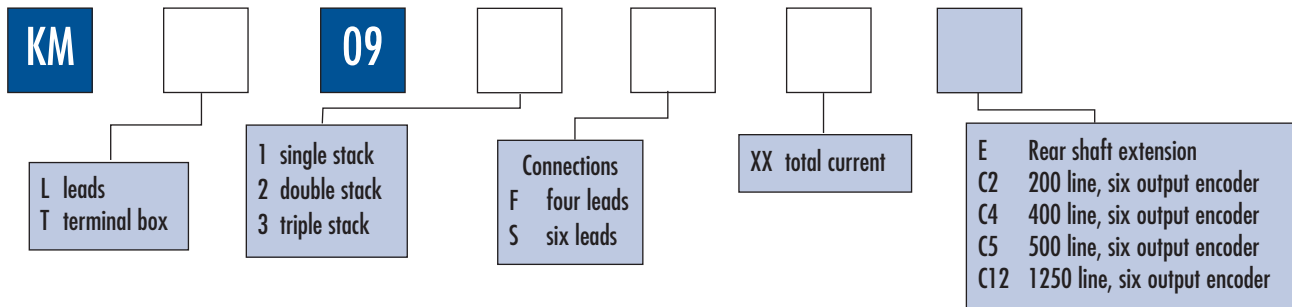

See next page for additional KM09 information

4-CONNECTION STEP MOTORS				
Model Number	Winding Specifications			
See Next page for options	Voltage (VDC)	Current (amperes)	Resistance (ohms)	Inductance (mH)
KM□091F05	3.0	2.7	1.1	11
KM□091F07	2.5	3.3	0.76	7.5
KM□091F13	1.3	6.6	0.19	1.9
KM□092F07	3.5	3.3	1.1	11
KM□092F13	1.7	6.5	0.27	2.9
KM□093F07	4.9	3.4	1.4	18
KM□093F08	4.0	4.0	0.99	13
KM□093F10	3.2	5.1	0.63	8.3
KM□093F14	2.5	6.8	0.36	4.5

6-CONNECTION STEP MOTORS								
Model Number	Winding Specifications							
	Unipolar				Bipolar Series			
See Next page for options	Voltage (VDC)	Current (amperes)	Resistance (ohms)	Inductance (mH)	Voltage (VDC)	Current (amperes)	Resistance (ohms)	Inductance (mH)
KM□091S02	9.3	1.0	9.3	47	13	0.70	19	190
KM□091S06	2.9	3.1	0.94	4.7	4.1	2.2	1.9	19
KM□091S08	2.1	3.8	0.55	2.9	2.9	2.7	1.1	11
KM□091S09	1.8	4.7	0.38	1.9	2.5	3.3	0.76	7.5
KM□092S09	2.5	4.6	0.54	2.8	3.4	3.2	1.1	11
KM□093S07	4.4	3.5	1.3	8.3	6.2	2.5	2.5	3.3
KM□093S10	3.5	4.8	0.72	4.5	4.8	3.4	1.4	18

KM09: Motor Dimensions

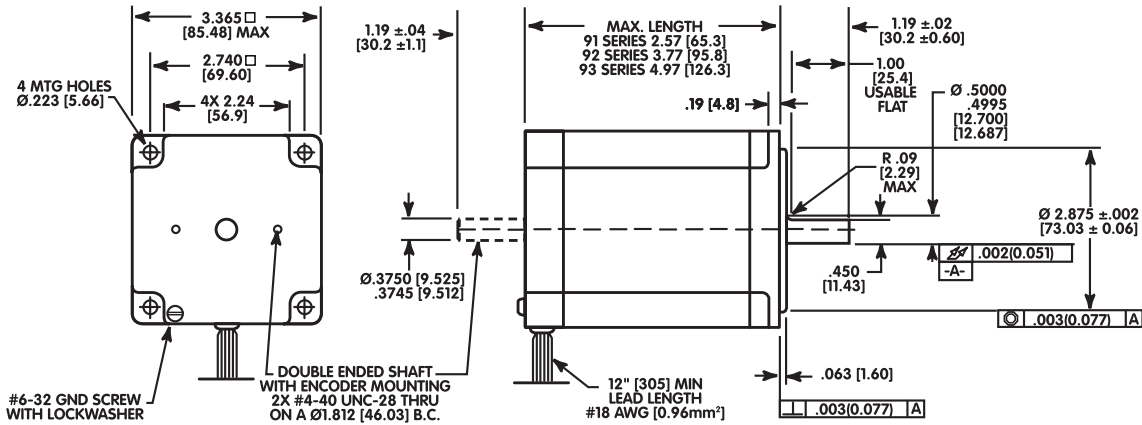

Add "E" to model number for double ended shaft. Example: KML092F07E

Encoder

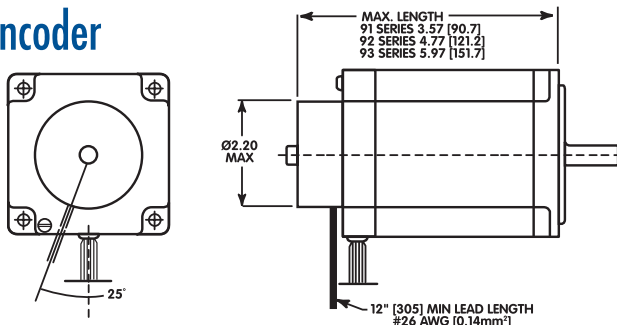

C2, C4, C500 Encoders

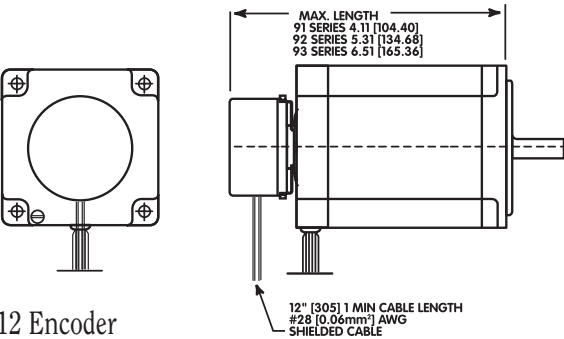

C12 Encoder

Add to Model Number:

- C2 200 lines per rev.
- C4 400 lines per rev.
- C5 500 lines per rev.
- C12 1250 lines per rev.

Outputs: A, B, Index,
 \bar{A} , \bar{B} , $\bar{\text{Index}}$

Differential Line Drivers supplied

Example: KML093S07C5 (triple stack, leaded, six leads, 3.5 amp winding)
 For encoder specification see page 22-23

Terminal Box

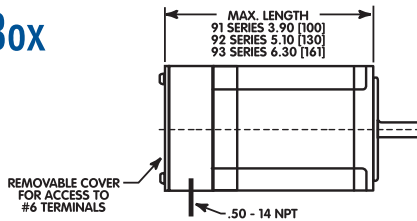

Change to Model Number:

Example: KMT093S07 (triple stack, terminal box, six leads, 3.5 amp winding)

Terminal Box w/Encoder

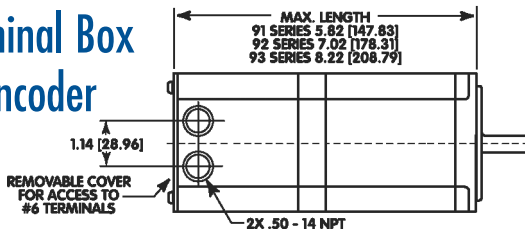

Change to Model Number:

Example: KMT092F07C12 (double stack, terminal box, four leads, 3.3 amp winding, C12 encoder)

KM09

36 V Bipolar - Full Step

36 volt data measured with the SS2000MD4 Modular Drive.

72 V Bipolar - Microstep

72 volt data measured with MD808 Modular Drive

170 V Bipolar - Microstep

170 volt data measured with SS2000D3, D3i, D6, or D6i Packaged Drive

KM091

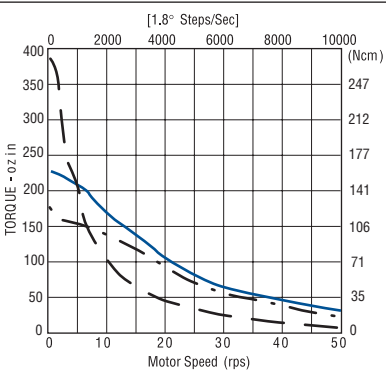

KM□ 091F05 - 2.5 A peak KM□ 091F13 - 2.5 A peak
KM□ 091F13 - 3.5 A peak

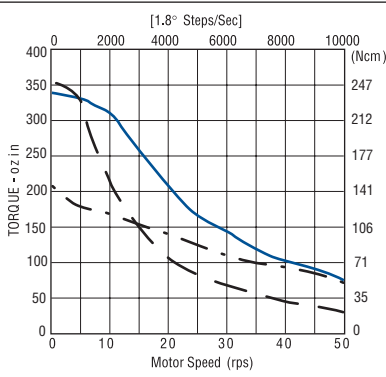

KM□ 091F07 - 4.0 A peak KM□ 091F13 - 4.0 A peak
KM□ 091F13 - 8.0 A peak

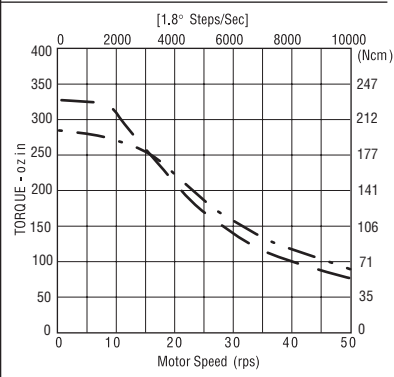

KM□ 091F05 - 3.0 A peak KM□ 091F07 - 3.0 A peak

KM092

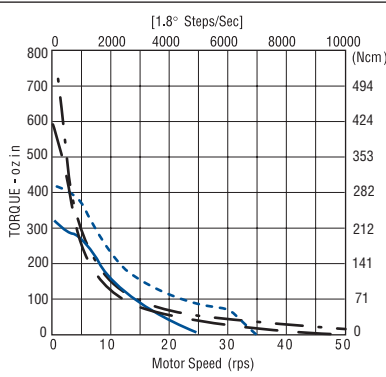

KM□ 092F07 - 2.5 A peak KM□ 092F07 - 3.5 A peak
KM□ 092F13 - 2.5 A peak KM□ 092F13 - 3.5 A peak

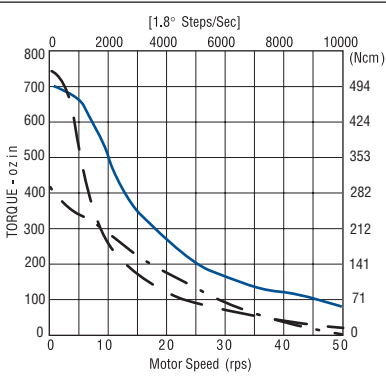

KM□ 092F07 - 4.0 A peak KM□ 092F13 - 4.0 A peak
KM□ 092F13 - 8.0 A peak

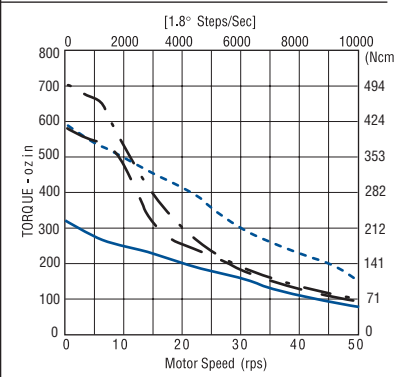

KM□ 092F07 - 3.0 A peak KM□ 092F07 - 4.0 A peak
KM□ 092F13 - 3.0 A peak KM□ 092F13 - 6.0 A peak

KM093

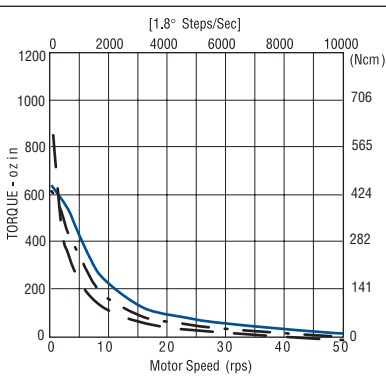

KM□ 093F07 - 2.5 A peak KM□ 093F10 - 2.5 A peak
KM□ 093F14 - 3.5 A peak

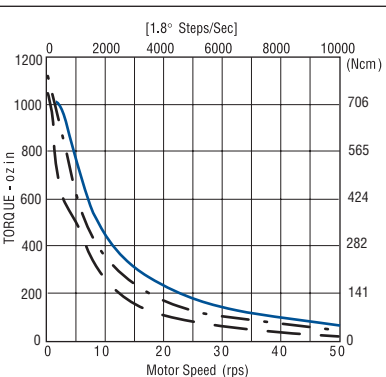

KM□ 093F07 - 4.0 A peak KM□ 093F10 - 7.0 A peak
KM□ 093F14 - 8.0 A peak

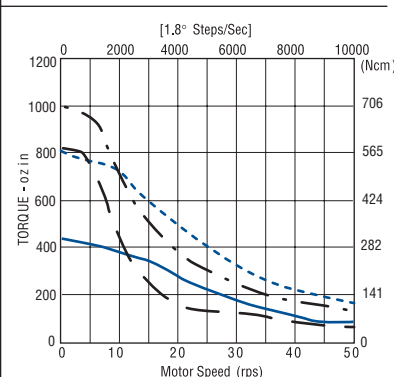

KM□ 093F07 - 3.0 A peak KM□ 093F10 - 6.0 A peak
KM□ 093F14 - 3.0 A peak KM□ 093F14 - 6.0 A peak

- The curves do not show system resonances which will vary with system mechanical parameters.
- Duty cycle is dependent on torque, speed, drive parameters, and heat sink conditions. Maximum case temperature is 100°C.

KM11

High Torque 170mm Frame Size (NEMA Size 42)

Performance Envelope

(see page 17 for detailed torque-speed curves)

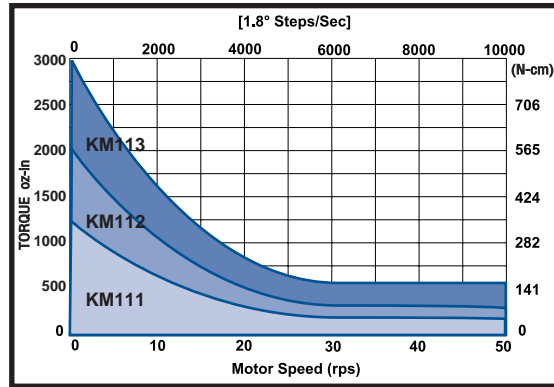
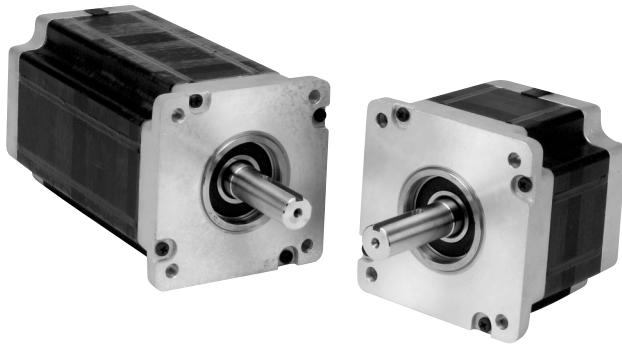

- Up to 200% rated torque reserve capacity
- $\pm 5\%$ typical step accuracy
- Standard terminal box, encoders, and precision gearheads available
- Available with four, six, or eight leads
- Customized configurations available



Motor Frame	Minimum Holding Torque		Rotor Inertia	*Weight		Maximum Shaft Load		Minimum Residual Torque
	Unipolar 2Ø on	Bipolar 2Ø on		Net	Ship	Overhang	Thrust	
	oz-in (N-cm)	oz-in (N-cm)	oz-in-s ² (kg-cm ²)	lb (kg)	lb (kg)	lb (kg)	lb (kg)	oz-in (N-cm)
KML111	1,030 (730)	1,450 (1,020)	0.078 (5.5)	11.0 (5.0)	12.2 (5.5)	75 (34.0)	130 (59.0)	42 (30)
KML112	1,950 (1,380)	2,750 (1,940)	0.155 (10.9)	18.4 (8.3)	19.6 (8.9)	75 (34.0)	160 (72.6)	84 (59)
KML113	2,650 (1,870)	3,750 (2,650)	0.229 (16.2)	25.7 (11.7)	26.9 (12.2)	75 (34.0)	160 (72.6)	106 (75)

* Weight for motor with leads.

KM11

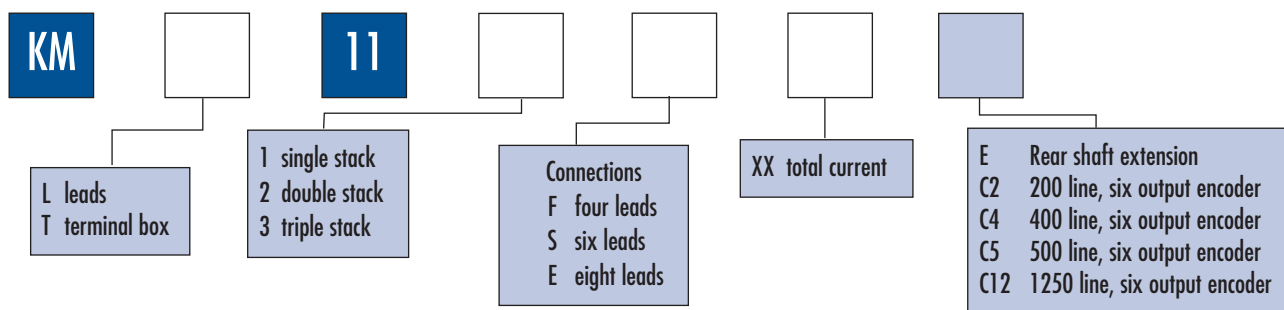

4-CONNECTION STEP MOTORS				
Model Number	Winding Specifications			
	Voltage (VDC)	Current (amperes)	Resistance (ohms)	Inductance (mH)
See Next page for options				
KM□111F05	6.3	2.7	2.33	40.4
KM□111F09	4.1	4.4	0.93	15.8
KM□111F11	3.2	5.5	0.58	10.1
KM□111F17	2.0	8.7	0.23	3.9
KM□111F21	1.7	10.7	0.16	2.8
KM□112F06	7.7	3.2	2.41	51.1
KM□112F08	6.0	4.0	1.51	31.2
KM□112F10	5.0	4.9	1.02	22
KM□112F13	3.2	7.9	0.41	8.4
KM□112F16	3.8	6.4	0.6	12.8
KM□112F20	2.5	9.9	0.25	5.5
KM□112F32	1.6	15.8	0.1	2.1
KM□113F06	10.2	3.1	3.29	78.5
KM□113F08	7.9	4.0	1.98	44.2
KM□113F10	6.5	4.9	1.32	30.7
KM□113F12	5.1	6.2	0.82	19.6
KM□113F16	4.0	8.0	0.5	11
KM□113F20	3.3	9.9	0.33	7.7
KM□113F31	2.2	15.4	0.14	3.2

8-CONNECTION STEP MOTORS								
Model Number	Winding Specifications							
	Bipolar Series				Bipolar Parallel			
	Voltage (VDC)	Current (amperes)	Resistance (ohms)	Inductance (mH)	Voltage (VDC)	Current (amperes)	Resistance (ohms)	Inductance (mH)
See Next page for options								
KM□111E08	6.3	2.7	2.33	40.4	3.2	5.5	0.58	10.1
KM□111E12	4.1	4.4	0.93	15.8	2.0	8.7	0.23	3.9
KM□111E15	3.3	5.3	0.63	11.1	1.7	10.7	0.16	2.8
KM□112E09	7.7	3.2	2.41	51.1	3.8	6.4	0.6	12.8
KM□112E11	6.0	4.0	1.51	31.2	3.1	8.1	0.38	7.8
KM□112E14	5.0	4.9	1.02	22	2.5	9.9	0.25	5.5
KM□112E22	3.2	7.9	0.41	8.4	1.6	15.8	0.1	2.1
KM□113E09	10.2	3.1	3.29	78.5	5.1	6.2	0.82	19.6
KM□113E11	7.9	4.0	1.98	44.2	4.0	8.0	0.5	11
KM□113E14	6.5	4.9	1.32	30.7	3.3	9.9	0.33	7.7
KM□113E22	4.2	7.7	0.55	13	2.2	15.4	0.14	3.2

KM11: Motor Dimensions

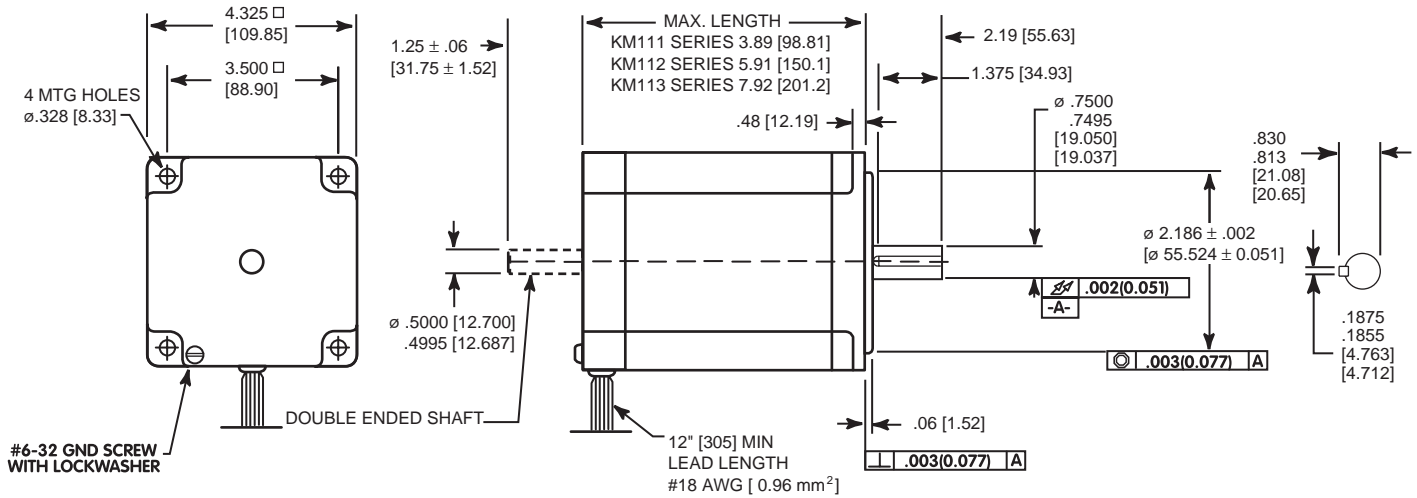

Encoder

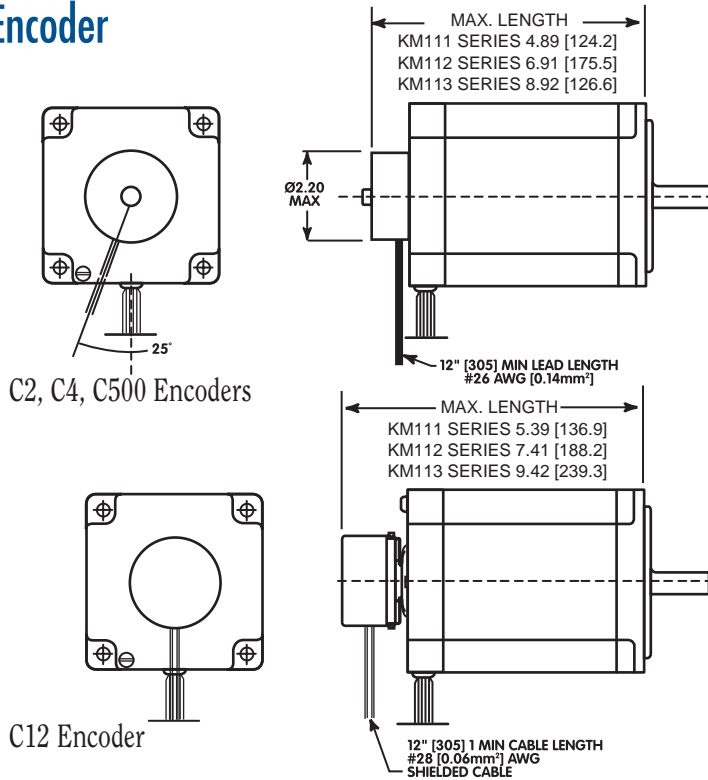

Add to Model Number:

- C2 200 lines per rev.
- C4 400 lines per rev.
- C5 500 lines per rev.
- C12 1250 lines per rev.

Outputs: A, B, Index,
A̅, B̅, Index̅

Differential Line Drivers supplied
Example: KML113F08C5

For encoder specification see pages 22-23

Terminal Box

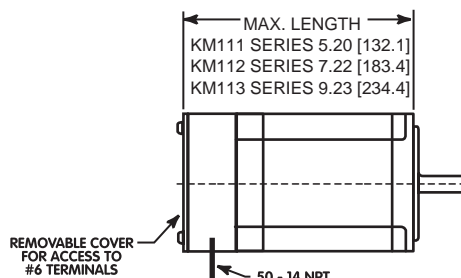

Change to Model Number:

Example: KMT113F08 (triple stack, terminal box, four leads, 4 amp winding)

KM11

72 V Bipolar - Microstep

72 volt data measured with MD808 Modular Drive

170 V Bipolar - Microstep

170 volt data measured with SS2000D3, D3i, D6, or D6i Packaged Drive

340 V Bipolar - Microstep

KM111

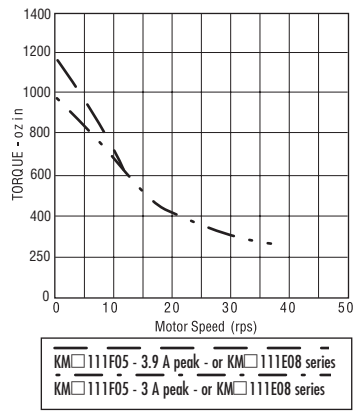
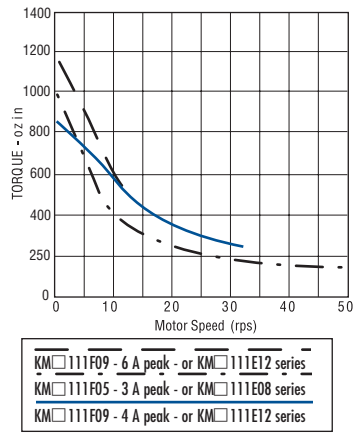
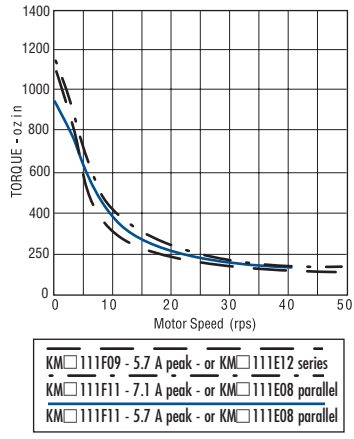

KM112

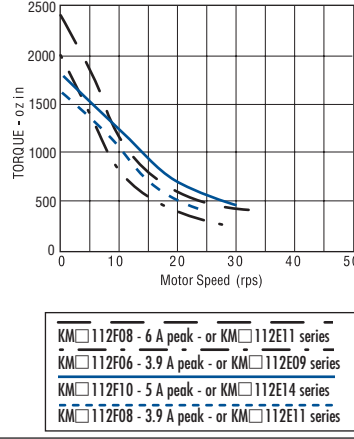
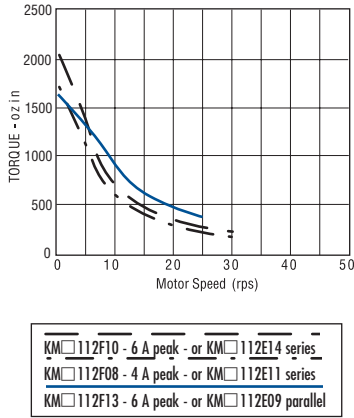
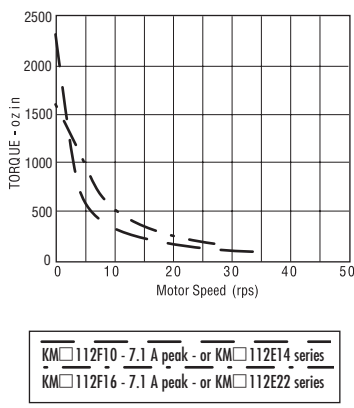

KM113

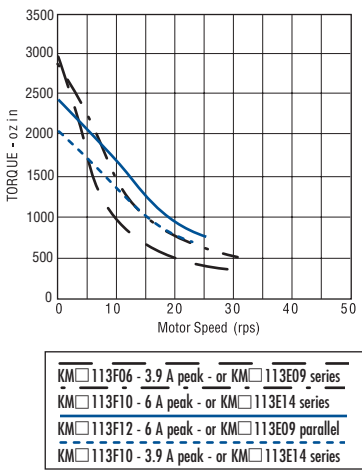
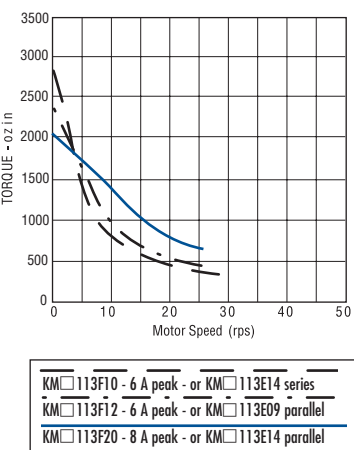
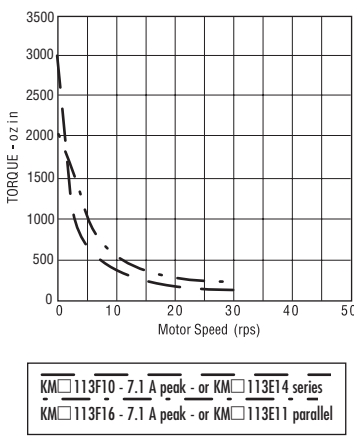

- The curves do not show system resonances which will vary with system mechanical parameters.
- Duty cycle is dependent on torque, speed, drive parameters, and heat sink conditions. Maximum case temperature is 100°C.

MH172

High Torque 170mm Frame Size (NEMA Size 66)

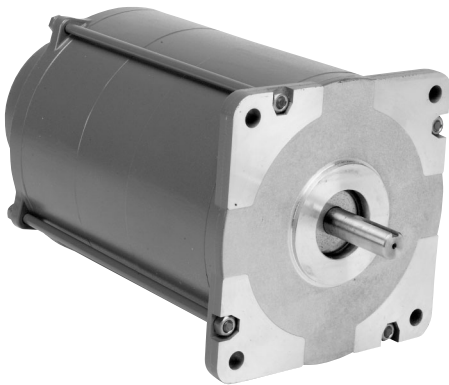

Performance Envelope

(see page 19 for detailed torque-speed curves)

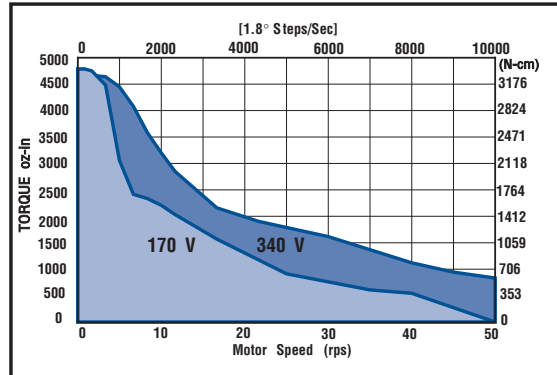

- Can withstand up to 2-1/2 time rated current (instantaneous)
- ± 5% typical step accuracy
- Available with eight connections
- Class F insulation system
- Standard keyway

MH172 Specifications

Motor Frame	Minimum Holding Torque Bipolar 2Ø On	Rotor Inertia	*Weight		Maximum Shaft Load		Minimum Residual Torque
			Net	Ship	Overhang	Thrust	
			oz-in (N-cm)	oz-in-s ² (kg-cm ²)	lb (kg)	lb (kg)	
MH172	5,330 (3,764)	0.870 (61.4)	53 (24)	62 (28)	100 (45.4)	150 (68)	50 (35)

* Weight for motor with leads.

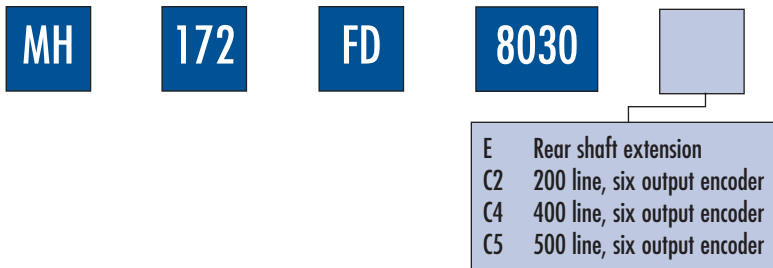

MH172

8-CONNECTION STEP MOTORS								
Model Number	Winding Specifications							
	Bipolar Series				Bipolar Parallel			
See below for options	Voltage (VDC)	Current (amperes)	Resistance (ohms)	Inductance (mH)	Voltage (VDC)	Current (amperes)	Resistance (ohms)	Inductance (mH)
MH172-FD-8030	3.25	10.6	0.31	8.5	1.6	21	0.077	2.1

Motor Dimensions*

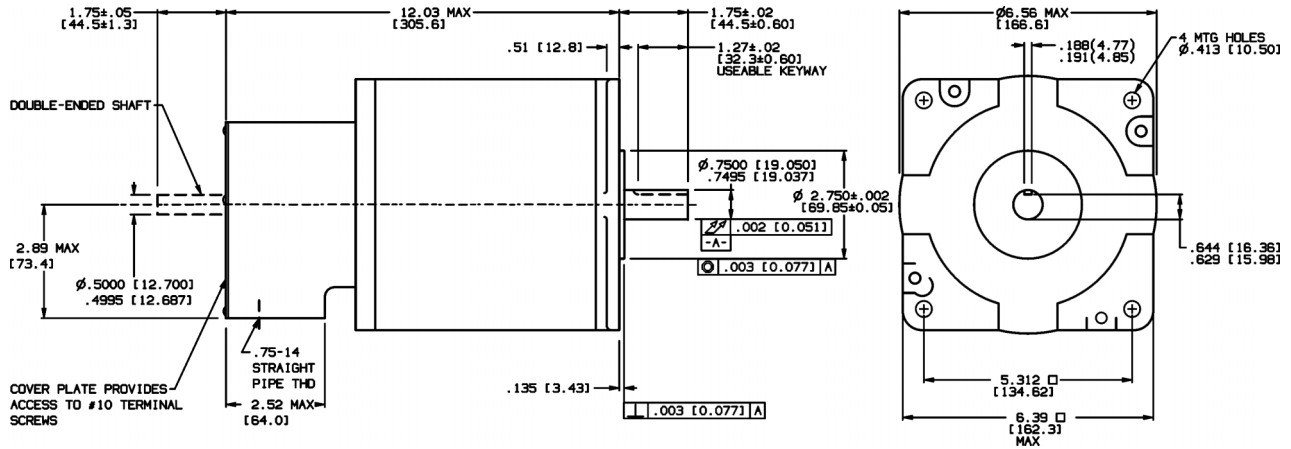

* Encoder if applicable, fits inside terminal box

170 V Bipolar - Microstep

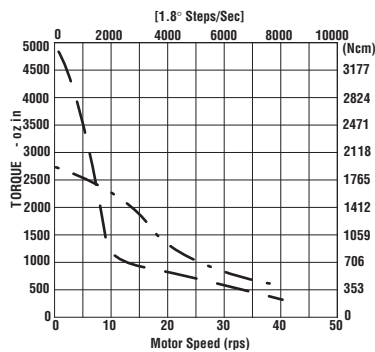

MH172-FD-8030 series - 12.0 A peak MH172-FD-8030 parallel - 12.0 A peak

340 V Bipolar - Microstep

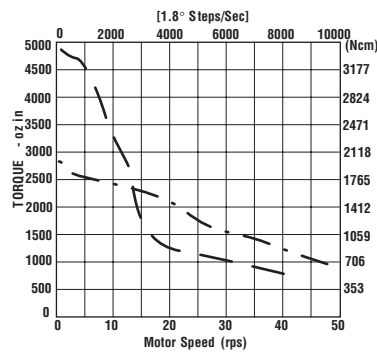

MH172-FD-8030 series - 12.0 A peak MH172-FD-8030 parallel - 12.0 A peak

MH172

- The curves do not show system resonances which will vary with system mechanical parameters.
- Duty cycle is dependent on torque, speed, drive parameters, and heat sink conditions. Maximum case temperature is 100°C.

MX09

Hazardous Duty 90mm Frame Size

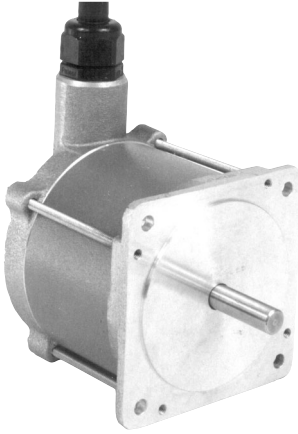

- Up to 150% rated torque reserve capacity
- ± 3% typical step accuracy
- Hazardous Duty:
UL Class 1, Division 1, Group D



4-CONNECTION STEP MOTORS

*Model Number	Min. Holding Torque Bipolar 2Ø on oz-in (N-cm)	Winding Specifications				Rotor Inertia oz-in-s ² (kg-cm ²)	Weight -Ship lb (kg)	Maximum Shaft Load		Min. Residual Torque oz-in (N-cm)
		Voltage (VDC)	Current (amperes)	Resistance (ohms)	Inductance (mH)			Overhang lb (kg)	Thrust lb (kg)	
MX91-FF-206U	180 (127)	3.0	3.0	1.0	10	0.0095 (0.67)	6 (2.7)	25 (11)	50 (23)	2.0 (1.4)
MX91-FF-402U		2.9	4.0	0.72	6.0					
MX91-FF-403U		1.1	6.0	0.18	1.5					
MX92-FF-206U	370 (261)	4.0	4.0	1.0	11	0.0174 (1.23)	9 (4.1)	25 (11)	50 (23)	4.0 (2.8)
MX92-FF-401U		1.9	7.0	0.28	2.8					
MX93-FF-206U	550 (388)	3.9	4.0	0.90	13	0.0265 (1.87)	11 (5)	25 (11)	50 (23)	7.0 (4.9)
MX93-FF-401U		3.2	5.0	0.65	8.0					
MX93-FF-402U		1.1	7.0	0.16	2.0					

* Change U to EU for double-ended shaft

NOTE: Refer to MOTIONEERING® for speed torque curves

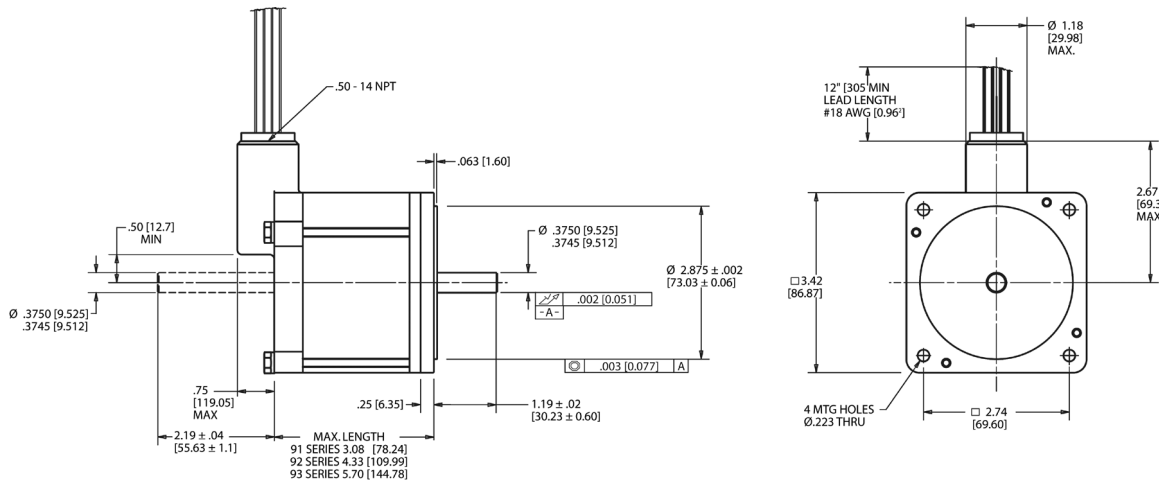

MX11

Hazardous Duty 110mm Frame Size

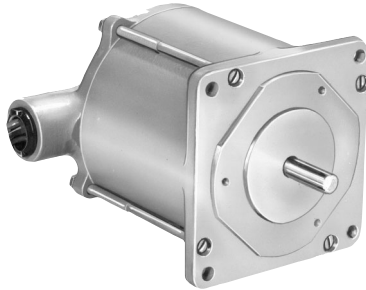

- Up to 200% rated torque reserve capacity
- ± 5% typical step accuracy
- Hazardous Duty:
UL Class 1, Division 1, Group D



4-CONNECTION STEP MOTORS										
*Model Number	Min. Holding Torque Bipolar 2Ø on oz-in (N-cm)	Winding Specifications				Rotor Inertia oz-in-s ² (kg-cm ²)	Weight - Ship lb (kg)	Maximum Shaft Load		Min. Residual Torque oz-in (N-cm)
		Voltage (VDC)	Current (amperes)	Resistance (ohms)	Inductance (mH)			Overhang lb (kg)	Thrust lb (kg)	
MX111-FF-401U	850 (600)	3.8	1.1	3.6	16	0.055 (3.93)	10 (4.5)	25 (11.3)	50 (22.7)	6 (4.24)
MX112-FF-401U	1390 (981)	1.7	2.7	0.64	2.5	0.114 (8.06)	18 (8.2)	25 (11.3)	50 (22.7)	12 (8.47)

* Change U to EU for double-ended shaft

NOTE: Refer to MOTIONEERING® for speed torque curves

Dimensions

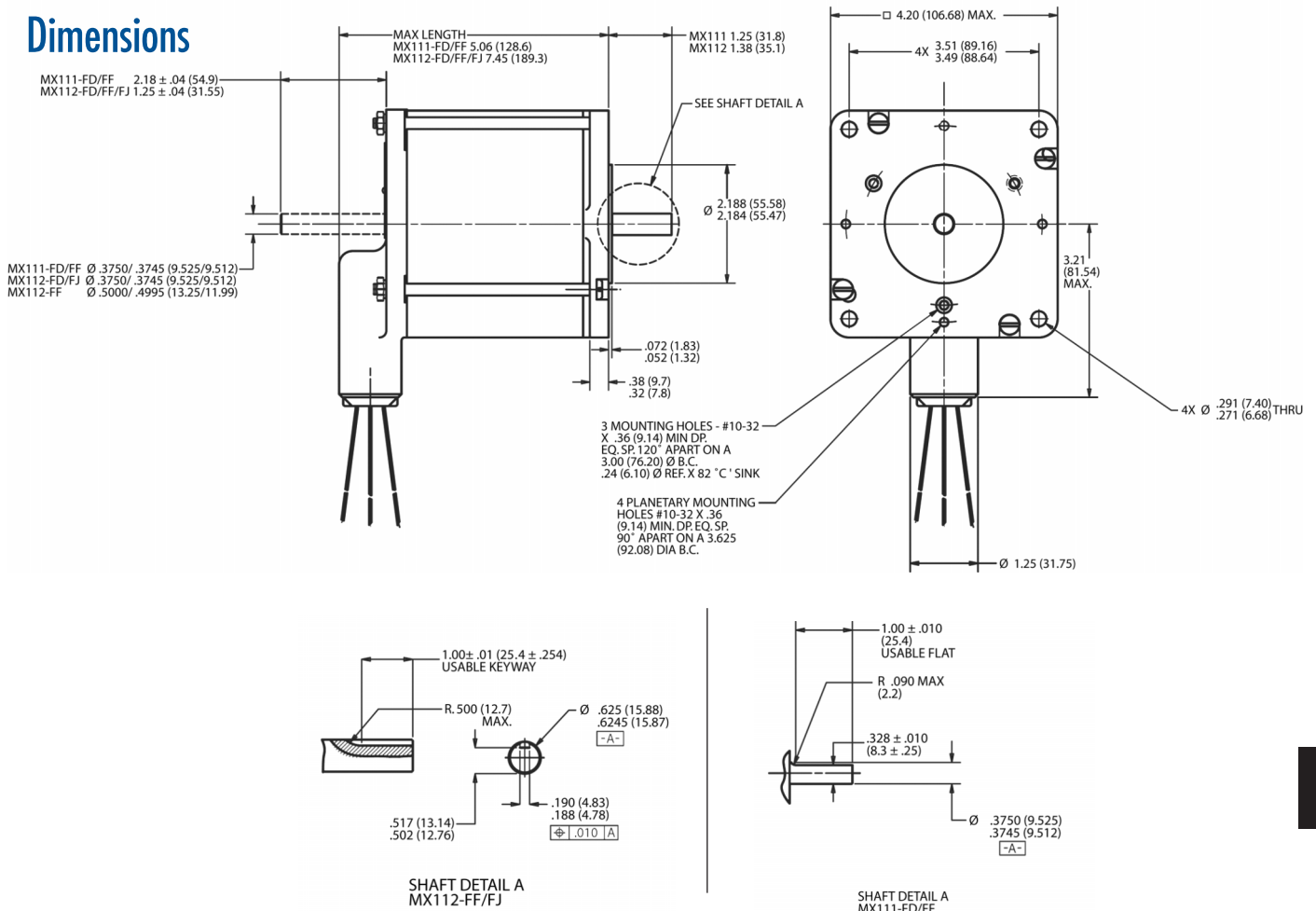

Encoders

Incremental Rotary Optical Kit Encoders



200, 400, 500 lines per revolution

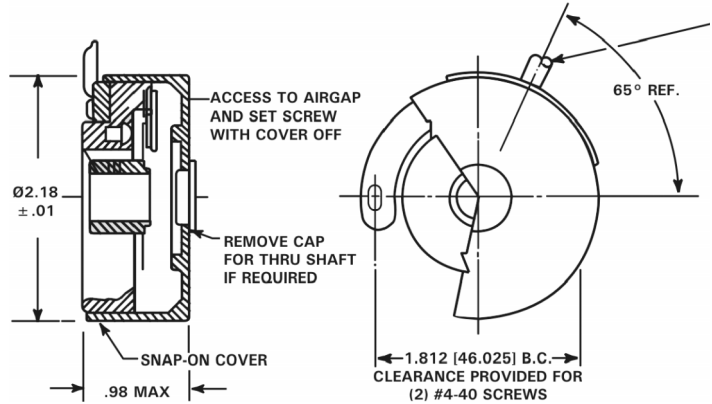

1250 lines per revolution

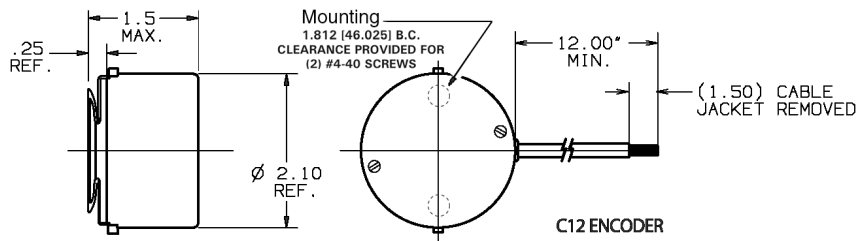

NOTE: 1250 lines per revolution

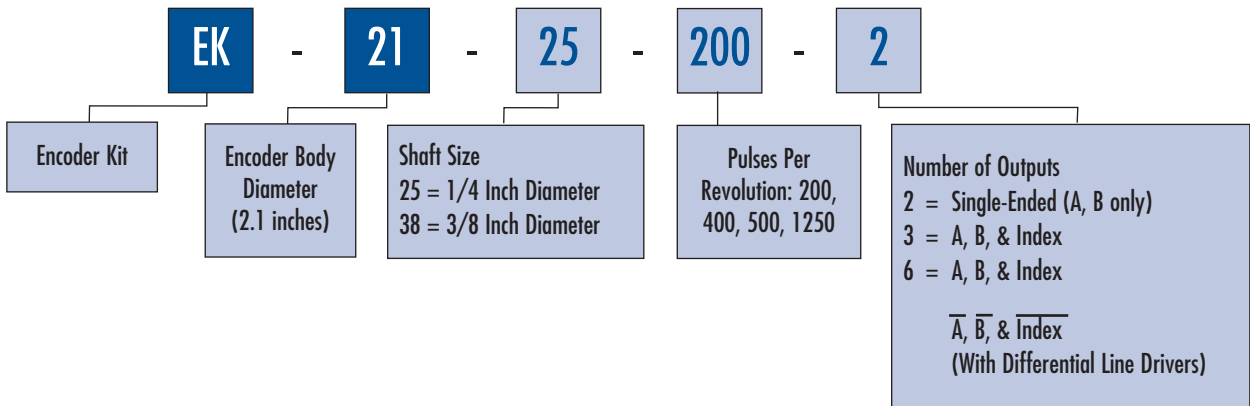

Encoders

	SPECIFICATIONS	200/400/500 LINES PER REV	1250 LINES PER REV
MECHANICAL	Weight	2.1 ounces	6 ounces
	Moment of Inertia	2.6 x 10 ⁻⁴ oz-in-sec ² max	5.0 x 10 ⁻⁴ oz-in-sec ²
	Bearing Life		L10 = 2 billion revolutions
	Acceleration	100,000 rad/sec ²	100,000 rad/sec ²
	Bore size	0.250 in or 0.375 in	0.250 in or 0.375 in
	Slew Speed	15,000 rpm max	7,000 rpm max
	Strain Relief	Withstands 10 lb pull on cable or wire bundle	Withstands 10 lb pull on cable or wire bundle
MOTOR INTERFACE	Mounting Holes	2 x #4-40 at 180 on a 1.812 dia bolt circle	2 x #4-40 at 180 on a 1.812 dia bolt circle
	Perpendicularity (Shaft-to-Mount)	0.005 in TIR	-
	Shaft Endplay	± 0.010 in	- 0.060 in
	Shaft Diameter	0.2495 / 0.2500 in	0.2495 / 0.2500 in
	Required	0.3745 / 0.3750 in	0.3745 / 0.3750 in
	Minimum Usable Shaft Length	0.056 in	Minimum Required 0.70 in
ELECTRICAL	Code	Incremental	Incremental
	Cycles Per Revolution	200, 400, 500, as specified	1250
	Supply Voltage	5 VDC	5 VDC
	Output Format	Dual channel quadrature, 45° min. edge separation	Dual channel quadrature, 45° min. edge separation
	Output Format Options	Index and complementary outputs	Index and complementary outputs
	Output Type, Less Complements	Square wave TTL compatible short-circuited protected capable of sinking 10 ma	Square wave TTL compatible short-circuited protected capable of sinking 10 ma
	Output Type, With Complements	Differential line drivers (26LS31) capable of sinking 20 ma	Differential line drivers (26LS31) capable of sinking 20 ma
	Frequency Response	100 kHz	100 kHz
	Frequency Modulation	±0.5% max. @ 50 kHz	1% max.
	Frequency Adulation	3.0 arc min. max. (zero runout)	3.0 arc min. max. (zero runout)
ENVIRONMENTAL	Operation Temperature	-10° C to +80° C (less complements) -10° C to +100° C (with complements)	0° C to +85° C
	Storage Temperature	-20° C to +100° C (less complements) -40° C to +100° C (with complements)	-30° C to +110° C
	Enclosure	Unsealed housing, (must be protected from harsh environments)	Unsealed housing, (must be protected from harsh environments)

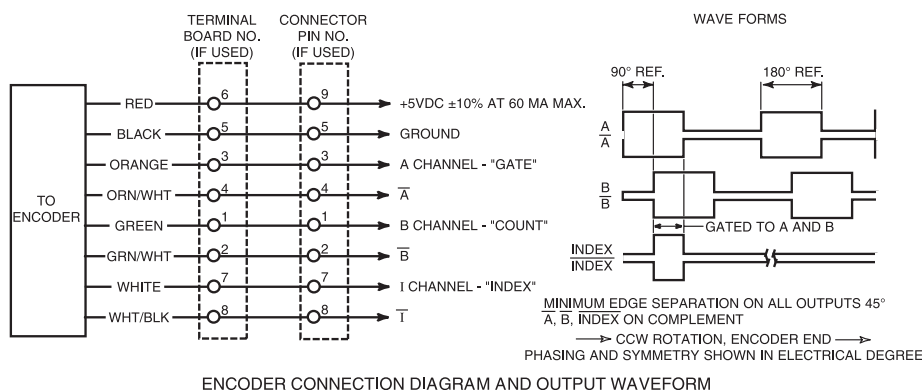

MOTONEERING® Application Software

Sizing and Selection Software

Step motor systems are often used in high performance positioning systems. The correct motor and drive are equally important for the system to meet performance and cost goals. To select a motor and drive for a given situation requires an analysis of the load, mechanical system and desired cycle times or speeds.



MOTONEERING® Software for Superior Electric, makes the selection process easy.

- Menu driven, Windows®-based program
- Automatically takes into account load, motor and drive parameters.
- Accommodates a wide variety of mechanisms: lead screw, rack and pinion, conveyor (belt and pulley), nip rolls, and rotary, as well as direct data entry

- All common metric and English units can be used; and the program converts data into the other available units
- Application and system data is organized in project folders that can be exported or imported for sharing with other users
- An extensive database of system combinations is incorporated. These include NEMA size 23, 34, 42, and 66 motors combined with drives having input voltages from 12 VDC to 240 VAC
- On-line help explains the programs functions, terms and equations.

MOTONEERING® software provides a versatile environment for choosing the optimum step system for your application and is available free of charge.

Application Assistance

There are two basic conditions that must be met for a step motor system to successfully drive a given load:

- The available motor torque must be greater than the required maximum load torque. As with all motors, the system will stall if the load torque is greater than the motor can produce.
- The inertia of the load must be within the motors capability. This is required for the motor to reliably start and control the load.

The first step in the selection process is to determine the load torque and inertia *as they appear to the motor*. Gear reducers, leadscrews, pulleys, etc. change the speed, torque and inertia requirements presented to the motor. The following pages show how to calculate these for various applications.

Once the load requirements are known:

- Compare the required torque at speed, to the available torque for a given motor drive combination. The available motor torque must be greater than the maximum load torque.
- In general, the load inertia, as presented to the motor, should be no more than 10 times the motor rotor inertia.

The temperature of the motor in a particular application depends on the duty cycle, ambient temperature, drive current, drive voltage, operating speed and heat sink conditions. Maximum case temperature of the motor is 100°C (212°F).

Application Assistance (Continued)

Leadscrew System

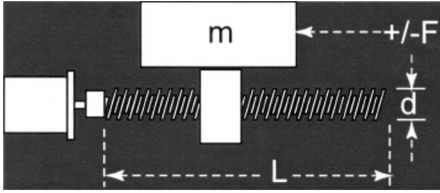

Variable Definitions:

L = length (in)	g = 386 in/sec ²
d = diameter (in)	F = Force (lb)
J = inertia (lb-in ²)	E = Efficiency (as a decimal)
ρ = Screw lead (in/rev)	w = weight of load (lb)

Step 1: Calculate Load Inertia ($J_{total\ load}$):

$$J_{load} = w * \rho^2 * (1/2 \pi)^2$$

$$J_{screw} = \pi / 32 * d^4 * L * \rho \text{ or } 1/2 * w * \rho^2$$

$$J_{total\ load} = J_{load} + J_{screw}$$

Step 2: Calculate Total Inertia (J_{total}):

$$J_{total} = J_{total\ load} + J_{motor}$$

J_{motor} is found in the Rotor Inertia table at the end of this section.

Note: If $J_{total\ load} > 10 * J_{motor}$, then this motor will not be applicable.

Step 3: Calculate the Torque in the System (T_L):

For a Horizontal leadscrew application, the formula for the system torque is: $T_L = (F * \rho) / (E * 2\pi)$

For a Vertical leadscrew application, the formula for the system torque is: $T_L = (((g * w) +/- F) * \rho) / (E * 2\pi)$

where E is the efficiency of the system and F any force that opposes the movement of the load with the exception of friction or gravity.

Step 4: Calculate the Torque Required to Obtain Base Speed (T_b):

$$T_b = J_{total} * V_b^2 * 0.00032$$

Step 5: Calculate Torque Required to Accelerate the System (T_a):

$$T_a = J_{total} * ((V_f - V_b) / t_{acc}) * 0.00064$$

t_{acc} is the rate of acceleration.

Cylinder/Rod System

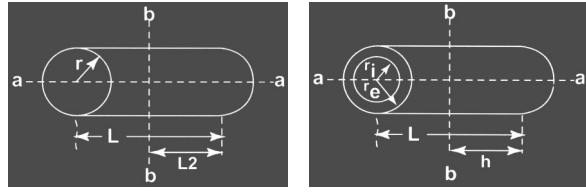

Variable Definitions:

r = radius (in)	r_i = inner radius (in)
L = length (in)	r_o = outer radius (in)
w = weight of cyl (lb)	L = length (in)
J = inertia (lb-in ²)	w = weight of cyl (lb)
V_b = Base speed (steps/sec)	J = inertia (lb-in ²)
V_f = Final speed (steps/sec)	V_b = Base speed (steps/sec)
	V_f = Final speed (steps/sec)

Step 1: Calculate Load Inertia (J_{load}):

Solid Cylinder:

$$\text{Inertia at Axis A: } J_{load} = 1/2 * w * r^2$$

$$\text{Inertia at Axis B: } J_{load} = 1/12 * w(3r^2 + L^2)$$

Hollow Cylinder:

$$\text{Inertia at Axis A: } J_{load} = 1/2 * w(r_o^2 + r_i^2)$$

$$\text{Inertia at Axis B: } J_{load} = 1/4 * w(r_o^2 + r_i^2 + h / 3)$$

Step 2: Calculate Total Inertia (J_{total}):

$$\text{Very simply: } J_{total} = J_{load} + J_{motor}$$

J_{motor} is found in the Rotor Inertia table at the end of this section.

Note: If $J_{load} > 10 * J_{motor}$, then this motor will not be applicable.

Step 3: Calculate the Torque in System (T_L):

$T_L = F * r$ where F is the Force in Pounds.

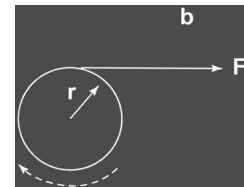

Step 4: Calculate Torque Required to Reach Base Speed (T_b):

$$T_b = J_{total} * V_b^2 * 0.00032$$

Step 5: Calculate Torque Required to Accelerate the System (T_a):

$$T_a = J_{total} * ((V_f - V_b) / t_{acc}) * 0.00064$$

Application Assistance (Continued)

Disc/Pulley System

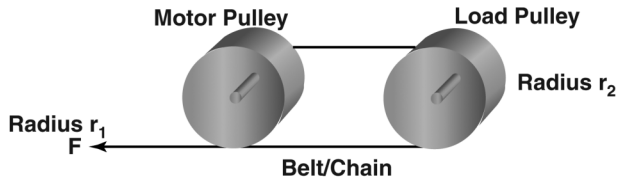

Variable Definitions:

r_1 = radius motor pulley (in) r_2 = radius load pulley (in)
 w_1 = weight motor pulley (lb) w_2 = weight load pulley (lb)
 V_b = Base speed (steps/sec) V_f = Final speed (steps/sec)
 J = inertia (lb-in²) F = Force required to rotate system (lb)

Step 1: Calculate Load Inertia ($J_{total\ load}$):

$$J_{motor\ pulley} = 1/2 * W_1 * r_1^2$$

$$J_{load\ pulley} = 1/2 * W_2 * r_2^2$$

$$J_{total\ load} = J_{motor\ pulley} + J_{load\ pulley}$$

Step 2: Calculate Total Inertia (J_{total}):

$J_{total} = J_{total\ load} + J_{motor}$
 J_{motor} is found in the Rotor Inertia table at the end of this section.

Note: If $J_{total\ load} > 10 * J_{motor}$, then this motor will not be applicable.

Step 3: Calculate the Torque in System (T_L):

$$T_L = F * r_1$$

Step 4: Calculate Torque Required to Reach Base Speed (T_b):

$$T_b = J_{total} * V_b^2 * 0.00032$$

Step 5: Calculate Torque Required to Accelerate the System (T_a):

$$T_a = J_{total} * ((V_f - V_b) / t_{acc}) * 0.00064$$

Nip Roller System

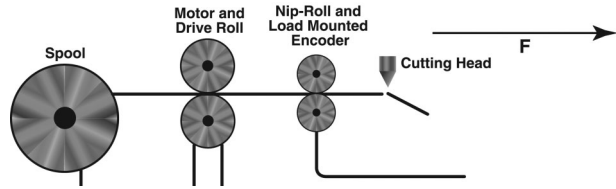

Variable Definitions:

F = Force (lb) J = inertia (lb-in²)
 r = radius (in) w = weight (lb)
 V_b = Base speed (steps/sec) V_f = Final speed (steps/sec)
 F = Force required to rotate system (lb)

Step 1: Calculate Load Inertia ($J_{total\ load}$):

Inertia of a roller or disc is calculated as:

$$J_{roll} = 1/2 * w * r^2$$

Repeat the above formula for each roller or disc that must be rotated as the load progresses.

$$J_{total\ load} = J_{spool} + J_{roll\ 1} + J_{roll\ 2} + J_{roll\ 3} + J_{roll\ 4} \text{ etc.}$$

Step 2: Calculate Total Inertia (J_{total}):

$J_{total} = J_{total\ load} + J_{motor}$
 J_{motor} is found in the Rotor Inertia table at the end of this section.

Note: If $J_{total\ load} > 10 * J_{motor}$, then this motor will not be applicable.

Step 3: Calculate the Torque in System (T_L):

$$T_L = F * r$$

Where r represents the radius of the roller or disc driven directly by the motor.

Step 4: Calculate Torque Required to Reach Base Speed (T_b):

$$T_b = J_{total} * V_b^2 * 0.00032$$

Step 5: Calculate Torque Required to Accelerate the System (T_a):

$$T_a = J_{total} * ((V_f - V_b) / t_{acc}) * 0.00064$$

Application Assistance (Continued)

Rack and Pinion System

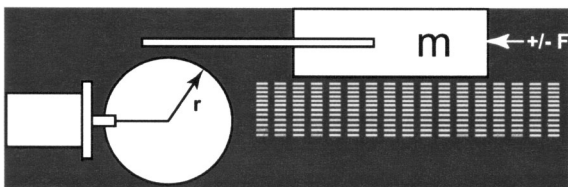

Variable Definitions:

w = weight of load (lb)	r = radius of pinion gear (in)
F = Force (lb)	$g = 386 \text{ in/sec}^2$
J = inertia (lb-in ²)	V_b = Base speed (steps/sec)
V_f = Final speed (steps/sec)	μ = Coefficient of friction between 2 surfaces.

Step 1: Calculate Load Inertia ($J_{\text{total load}}$):

$$J_{\text{pinion}} = 1/2 * W * r^2$$

$$J_{\text{rack}} = W * r^2$$

$$J_{\text{total load}} = J_{\text{pinion}} + J_{\text{rack}}$$

Step 2: Calculate Total Inertia (J_{total}):

$$J_{\text{total}} = J_{\text{total load}} + J_{\text{motor}}$$

J_{motor} is found in the Rotor Inertia table at the end of this section.

Note: If $J_{\text{total load}} > 10 * J_{\text{motor}}$, then this motor will not be applicable.

Step 3: Calculate the Torque in System (T_L):

For or horizontally positioned Rack and Pinion applications, Torque for the system is calculated as:

$$T_L = w * \mu * r$$

The value for μ can be found on the Coefficient of Friction table at the end of this section.

For vertically positioned Rack and Pinion applications, Torque for the system is calculated as:

$$T_L = ((g * w) + (w * \mu)) * r$$

Step 4: Calculate Torque Required to Reach Base Speed (T_b):

$$T_b = J_{\text{total}} * V_b^2 * 0.00032$$

Step 5: Calculate Torque Required to Accelerate the System (T_a):

$$T_a = J_{\text{total}} * ((V_f - V_b) / t_{\text{acc}}) * 0.00064$$

Conveyer System

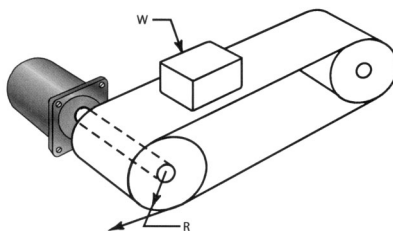

Variable Definitions:

w = weight (lb)	r = radius (in)
J = inertia (lb-in ²)	V_b = Base speed (steps/sec)
V_f = Final speed (steps/sec)	F = Force required to move the system (lb)

Step 1: Calculate Load Inertia ($J_{\text{total load}}$):

$$J_{\text{motor roll}} = 1/2 * W_{\text{motor roll}} * r_{\text{motor roll}}^2$$

$$J_{\text{driven roll}} = (1/2 * W_{\text{driven roll}} * r_{\text{driven roll}}^2) / (r_{\text{driven roll}} / r_{\text{motor roll}})^2$$

$$J_{\text{belt}} = W_{\text{belt}} * r_{\text{motor roll}}^2$$

$$J_{\text{load}} = W_{\text{load}} * r_{\text{motor roll}}^2$$

Additional driven roll inertias must be added to the calculation as required.

$$J_{\text{total load}} = J_{\text{motor roll}} + J_{\text{driven roll}} + J_{\text{belt}} + J_{\text{load}}$$

Step 2: Calculate Total Inertia (J_{total}):

$$J_{\text{total}} = J_{\text{total load}} + J_{\text{motor}}$$

J_{motor} is found in the Rotor Inertia table at the end of this section.

Note: If $J_{\text{total load}} > 10 * J_{\text{motor}}$, then this motor will not be applicable.

Step 3: Calculate the Torque in System (T_L):

$$T_L = F * r$$

Where r represents the radius of the roller or disc driven directly by the motor.

Step 4: Calculate Torque Required to Reach Base Speed (T_b):

$$T_b = J_{\text{total}} * V_b^2 * 0.00032$$

Step 5: Calculate Torque Required to Accelerate the System (T_a):

$$T_a = J_{\text{total}} * ((V_f - V_b) / t_{\text{acc}}) * 0.00064$$

Application Assistance (Continued)

Rotor Inertia

Model	Rotor Inertia		
	oz-in-s ²	lb-cm ²	lb-in ²
KM060	0.0015	0.109	0.037
KM061	0.0034	0.240	0.082
KM062	0.0056	0.395	0.135
KM063	0.0084	0.593	0.203
KM091	0.016	1.13	0.386
KM092	0.031	2.19	0.748
KM093	0.047	3.32	1.134
KM111	0.078	5.5	1.882
KM112	0.155	10.9	3.740
KM113	0.229	16.2	5.526
KM172	0.87	61.4	20.993

Density of Materials

Material	Density	
	lb/in ³	g/cc
Acryl	.0433	1.199
Aluminum	.0975	2.700
Bakelite	.0469	1.299
Brass	.3069	8.498
Bronze	.3213	8.897
Copper	.3213	8.897
Glass	.0939	2.600
Iron	.2852	7.897
Iron (cast)	.2635	7.296
Magnesium	.0614	1.700
Nickel	.3177	8.797
Nylon	.0412	1.141
Rubber	.0433	1.199
Steel	.2816	7.798
Teflon	.0794	2.199

Coefficients of Static Friction

Dry Contact Unless Noted	
Steel on Steel	0.58
Steel on Steel (lubricated)	0.15
Aluminum on Steel	0.45
Copper on Steel	0.22
Brass on Steel	0.19
Teflon on Steel	0.04

Leadscrew Efficiencies

Type	High	Median	Low
Ball - Nut	95%	90%	85%
Acme with metal nut **	55%	40%	35%
Acme with plastic nut	85%	65%	50%

** Since metallic nuts usually require a viscous lubricant, the coefficient of friction is both speed and temperature dependent.

Length Conversion Factors §

A \ B	mm	cm	m	inch	feet
mm	=====	0.1	0.001	0.03937	0.003281
cm	10	=====	0.01	0.3937	0.03281
m	1000	100	=====	39.37	3.281
inch	25.4	2.54	0.0254	=====	0.08333
feet	304.8	30.48	0.3048	12	=====

Force Conversion Factors §

A \ B	g	kg	oz	lb	Newton
g	=====	0.001	0.03527	0.002205	0.0098
kg	1000	=====	35.27	2.205	9.807
oz	28.35	0.02835	=====	0.0625	0.278
lb	453.6	0.4536	16	=====	4.448
Newton	102	0.102	3.597	0.2248	=====

Inertia Conversion Factors §

A \ B	kgm ²	kgcm ²	oz-in-sec ²	lb-in ²	lb-in-sec ²	lb-ft-sec ² (slug ft ²)
kgm ²	=====	1.00 x 10 ⁴	1.416 x 10 ²	3.418 x 10 ³	8.851	7.376 x 10 ¹
kgcm ²	1.00 x 10 ⁻⁴	=====	1.416 x 10 ⁻²	3.418 x 10 ⁻¹	8.851 x 10 ⁻⁴	7.376 x 10 ⁻⁵
oz-in-sec ²	7.062 x 10 ⁻³	7.061 x 10	=====	2.413 x 10	6.250 x 10 ⁻²	5.208 x 10 ⁻³
lb-in ²	2.926 x 10 ⁻⁴	2.926	4.144 x 10 ⁻²	=====	2.590 x 10 ⁻³	2.158 x 10 ⁻⁴
lb-in-sec ²	1.130 x 10 ⁻¹	1.130 x 10 ³	1.600 x 10	3.861 x 10 ²	=====	8.333 x 10 ⁻²
lb-ft-sec ² (slug ft ²)	1.356	1.356 x 10 ⁴	1.920 x 10 ²	4.633 x 10 ⁵	1.200 x 10 ¹	=====

Torque Conversion Factors §

A \ B	N-m	N-cm	kgm*	oz-in	lb-ft	lb-in
N-m	=====	1.00 x 10 ²	1.020 x 10 ⁻¹	1.416 x 10 ²	7.376 x 10 ⁻¹	8.851
N-cm	1.000 x 10 ⁻²	=====	1.020 x 10 ⁻³	1.416	7.376 x 10 ⁻³	8.851 x 10 ⁻²
kgm*	9.807	9.807 x 10 ²	=====	1.389 x 10 ³	7.233	8.680 x 10 ¹
oz-in	7.062 x 10 ⁻³	7.062 x 10 ⁻¹	7.201 x 10 ⁻⁴	=====	5.283 x 10 ⁻³	6.250 x 10 ⁻²
lb-ft	1.356	1.356 x 10 ²	1.383 x 10 ⁻¹	1.920 x 10 ²	=====	1.200 x 10 ¹
lb-in	1.130 x 10 ⁻¹	1.130 x 10 ¹	1.152 x 10 ⁻²	1.600 x 10 ¹	8.330 x 10 ⁻²	=====

* Also written as kpm, kpcm, and pcm, respectively, to denote the force equivalent of the kg and g mass.

Speed Conversion Factors §

A \ B	rpm	rps	Rad / sec	* step / sec
rpm	=====	0.01667	0.1047	3.333
rps	60	=====	6.283	200
Rad / sec	9.552	0.1592	=====	31.83
* step / sec	0.3	0.005	0.03142	=====

* Step rates are for 1.8° step motors (200 steps / Rev)

§ Multiply units of "A" by indicated factor to obtain units of "B".

Technical Notes

Characteristics of Superior Electric Step Motors

- Brushless, permanent magnet motors
- Operate in full-step (1.8°) or half-step (0.9°) increments
- Microstepping provides increments as small as 0.0072°
- Accuracies of $\pm 2\%$ (0.036°) for size 23 and 34 motors, and $\pm 5\%$ (0.09°) for size 42 and 66 motors
- Speeds up to 20,000 steps per second (6,000 rpm)
- Holding torque ratings from 54 to 5,330 oz-in (38 to 3,764 N-cm)
- Wide range of configurations and frame sizes
- Easily adapted to different control types, including microprocessor based systems
- Class B insulation, operate at ambient temperatures from -40°C to $+65^\circ\text{C}$ (-40°F to $+149^\circ\text{F}$)
- No brushes, ratchets or detents to wear out
- Lubricated-for-life ball bearings

Construction of Step Motors

A Superior Electric step motor is a brushless motor consisting of a rotor and a stator assembly. The illustration shows the internal construction and tooth alignment of the motor. The fine teeth, evenly spaced around the entire diameter, provide the incremental angular rotation that results in mechanical motion. Superior Electric step motors are constructed with a 48-50 or a 52-50 tooth pitch configuration. The second number, 50, refers to the number of teeth on the rotor. The 50 teeth, combined with the two phase winding configuration and permanent magnet construction, deliver a 1.8° step angle. Both configurations have a slightly different tooth pitch on the stator (48 or 52) to provide smoother operation and softer step-to-step motion with less resonance or mechanical instability at low speed. The 52 tooth stator design is used in the new KM motors to provide extra torque. Superior Electric holds the original patent on the 48-50 design.

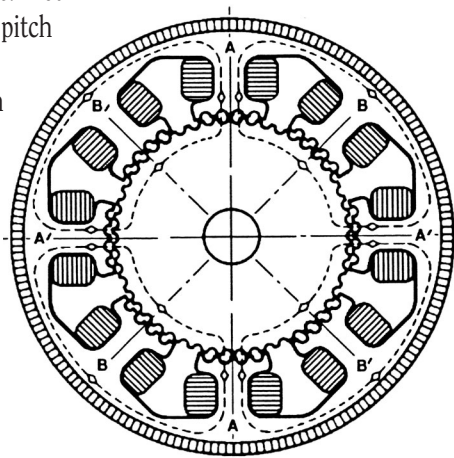

Comparison of Servomotors versus Step Motors

Often, when a motion control system is being specified, the designer must choose between a step motor system and a servomotor system. In most cases, a well designed step motor system will perform as well or better than a servomotor, and at lower cost. The following comparison of the characteristics of the two types of motors outlines some of the advantages of step motors for motion control.

Servomotor Characteristics

- Require complex, expensive control systems
- Position sensing devices needed for feedback to control
- Relatively low torque for size
- Thermally inefficient
- Control system must be “tuned” to load; must be “retuned” if load is changed
- Brushes on DC servomotors subject to wear

Superior Electric Step Motor Characteristics

- Relatively inexpensive
- Can be operated “open-loop” (no position feedback required)
- Noncumulative step error
- Simple control electronics can be used
- Brushless construction aids reliability
- Maintenance free
- Will not be damaged if stalled
- High torque for size
- Maintain position when at rest

Technical Notes (Continued) Stepping Techniques

The terms full-step, half-step and microstep are commonly used in the discussion of step motors.

A standard 1.8° step motor has 200 discrete positions in a full 360° revolution. Since 360° divided by 200 equals 1.8°, the motor shaft will advance 1.8° each time the motor is given a digital command to take one step. This is known as a full-step.

The term “half-step” indicates a 0.9° step angle (half of a full 1.8° step). This is achieved with a switching technique that alternately applies positive current, no current, and negative current to each winding in succession.

The term “microstep” refers to a more sophisticated form of control which goes beyond the simple switching of power between phase A and phase B of the motor windings, and takes control of the amount of current being sent to the individual windings. Microstepping permits the shaft to be positioned at places other than the 1.8° or 0.9° locations provided by the full-step and half-step methods. Microstepping positions occur between these two angular points in the rotation of the rotor.

The most commonly used microstep increments are 1/5, 1/10, 1/16, 1/32, 1/125 and 1/250 of a full step. Microstep increments chosen by Superior Electric simplify control of both US and metric units of measurement, and also allow finer positioning resolution. While a full step of 1.8° will give a 0.001 inch resolution when the motor is driving through a lead screw which has a 0.2000 inch lead, resolutions of 0.000008 inch or less are possible using microstepping.

A major benefit of microstepping is that it reduces the amplitude of the resonance that occurs when the motor is operated at its natural frequency or at sub-harmonics of that frequency. The improved step response and reduced amplitude of the natural resonances result from the finer step angle.

Switching Sequence For Operation From Bipolar Drives

Full-Step (Two-Phase On)
Energizing Sequence*

Step	Phase	
	A	B
1	+1	+1
2	+1	-1
3	-1	-1
4	-1	+1
1	+1	+1

Full-Step (One-Phase On)
Energizing Sequence*

Step	Phase	
	A	B
1	+1	–
2	–	-1
3	-1	–
4	–	+1
1	+1	–

Half-Step Phase Energizing Sequence*

Step	Phase	
	A	B
1	+1	+1
2	+1	–
3	+1	-1
4	–	-1
5	-1	-1
6	-1	–
7	-1	+1
8	–	+1
1	+1	+1

* Rotation is clockwise as viewed from label end of motor.

For counterclockwise rotation, sequence should go from bottom to top of chart.

Switching Sequence For Operation From Unipolar Drives

Four Step Input Sequence (Full-Step Mode)*

Step	SW1	SW2	SW3	SW4
1	ON	OFF	ON	OFF
2	ON	OFF	OFF	ON
3	OFF	ON	OFF	ON
4	OFF	ON	ON	OFF
1	ON	OFF	ON	OFF

Eight Step Input Sequence (Half-Step Mode)*

Step	SW1	SW2	SW3	SW4
1	ON	OFF	ON	OFF
2	ON	OFF	OFF	OFF
3	ON	OFF	OFF	ON
4	OFF	OFF	OFF	ON
5	OFF	ON	OFF	ON
6	OFF	ON	OFF	OFF
7	OFF	ON	ON	OFF
8	OFF	OFF	ON	OFF
1	ON	OFF	ON	OFF

* Rotation is clockwise as viewed from label end of motor. For counterclockwise rotation, sequence should go from bottom to top of chart.

Technical Notes (Continued)

Torque vs. Speed Characteristics

Many factors determine the torque vs. speed characteristics of a Step Motor. These include the design of the drive system and the voltage supplied to the motor, as well as the inductance rating of the motor used.

Effects of Drive Design

Drive design is an important factor in determining the overall performance which will be obtained. The types of drives, and their effects on motor performance, are as follows:

L/R Drives – This design was the basis for most older drives and is still used on some existing drives. It allows half-or full-step motor operation, but does not permit variable control of current level. L/R drives also require dropping resistors, which reduce motor efficiency. L/R drives provide satisfactory performance at lower stepping rates, but do not have good high speed capabilities. This is the most basic drive design.

Constant Current Chopper Drives – These drives maintain relatively constant current to the motor at all speeds, and therefore offer good stepping performance at rates up to approximately 10,000 steps per second. Although more costly and complex than L/R drives, they allow use of features such as closed-loop control, microstepping, current boost, and stabilization that improve motor performance.

Line Operated, High Voltage Chopper Drives – These drives deliver higher voltage to the motor for optimum high speed performance. They are also able to operate larger motors to provide high performance and excellent efficiency. Since they do not need bulky stepdown transformers, line operated drives are more compact than other chopper drives.

Effects of Motor Voltage

Motor performance at mid-range and high-range speeds can be improved by increasing the voltage to the motor. However, the motor will operate at a high temperature when the voltage is increased, so some means of cooling may be necessary. In general, motor supply voltage does not affect operation at lower speeds.

Motor Inductance Effects

For a given supply voltage, a low inductance motor will give better performance at high speeds than a high inductance motor, but will operate at a higher temperature. This is true because current will increase faster in a low inductance winding, each time the winding power is switched. High inductance motors yield higher maximum torque and operate cooler, but their top speed is limited and torque falls off more rapidly as speed rises, versus a lower inductance motor.

Angular Position Deviation

When a load is applied to a step motor shaft, the shaft will rotate slightly from the no load position. The Angular Position Deviation curve shows shaft deviation from the no load position vs. percent of rated holding torque. This curve is valid for all Superior Electric 1.8° step motors.

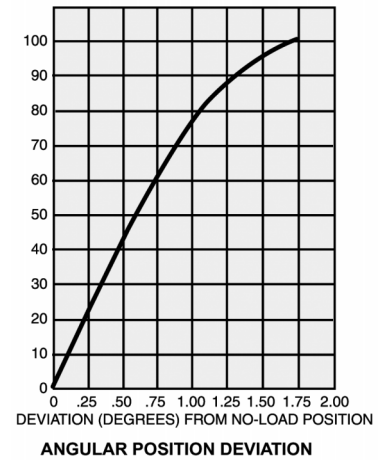

NOTE: Proper construction of the mechanism of the driven load is essential in order to accurately achieve a true versus theoretical position.

Connection Diagrams

4 Lead Motors

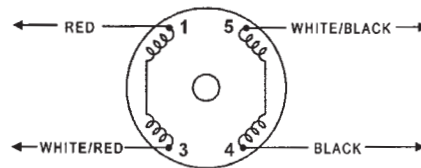

6 Lead Motors

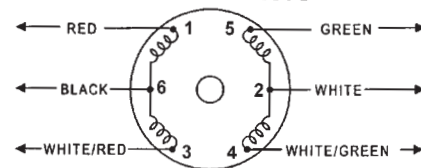

8 Lead Motors, Series Connected

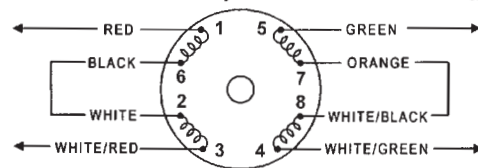

8 Lead Motors, Parallel Connected

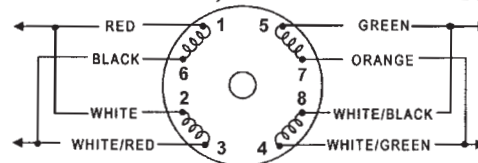

NOTE: Numbers identify terminal board connections.

Standard Options

Double End Shafts

These motors have an output shaft at both ends. Motors with double end shafts are used with an encoder, to mount a knob for turning the motor shaft manually, etc. NEMA size 23 and 34 motors with double end shafts have two tapped holes in the rear end bell for mounting encoders. Motors with shafts at both ends are identified with a letter E suffix added to the type number. See individual sections for detailed ordering information.

Encoders

Superior Electric offers encoders which can be supplied as kits for mounting to existing NEMA 23 or 34 motors with double end shafts, or which can be supplied as an integral part of all size motors. The encoders are available with outputs of 200, 400, 500 or 1250 pulses-per-revolution. See individual motor sections for information on ordering a motor with an integral encoder. For kit type numbers and encoder specifications, see pages 22-23.

Gearheads

Motors are available with precision gearheads. Contact factory for details.

- NEMA Size 23, 34, 42
- Ratio from 3:1 to 100:1
- Continuous output torque up to 25,600 oz-in (18,000 N-cm)
- Peak output torque up to 42,500 oz-in (30,000 N-cm)
- Backlash less than 30 arc-minutes
- Minimum efficiency 85%

Modifications

Many types of modifications are available. Please contact us with your specific requirements.

Shaft Modifications

A variety of motor output shaft modifications can be supplied. These include special flats and keyways, lengths, diameters, through holes and similar changes which may be needed to allow mounting of timing belts, pulleys or gears or to facilitate mounting the motor to the equipment being driven.

Electrical Modifications

Motors can be supplied with a number of electrical modifications, including nonstandard lead lengths, electrical connectors and special windings.



Definitions

1.1 COMMAND PULSE RATE: Command pulse rate is the rate at which successive command pulses are applied to the motor by the drive circuit.

1.2 DETENT TORQUE: Detent torque is the lowest value of torque (for a complete revolution) which can be applied to the motor's shaft which causes the rotor to advance to the next detent position with the stator winding de-energized and not connected to one another in any way electrically.

1.3 DIELECTRIC WITHSTAND VOLTAGE: Dielectric withstand voltage is the maximum RMS value of a 50 to 60 Hz voltage which may be applied to the motor (winding to winding, or winding to frame, as specified) without avalanche breakdown of the insulation occurring within 60 seconds from the time of the application of the test voltage. Reactive components of current are to be disregarded. Avalanche breakdown is defined as a sudden discontinuity in the rate of change of current with change in voltage (di/dv).

1.4 DIRECTION OF ROTATION: The direction of rotation of the shaft is determined by viewing the stepping motor facing the shaft extension associated with the mounting surface. The standard (positive) direction of shaft rotation is CW.

1.6 GENERATED EMF: Generated EMF is the counter-electromotive force (CWMF), also called "back EMF" (EMF), generated by the rotation of the rotor of a hybrid or Permanent Magnet motor when the phase windings are not energized and are open circuited. It is measured as the peak-to-peak value of the generated voltage of one winding when the rotor is driven at a constant angular velocity or 1000 rpm. It is reported as peak volts (half of the peak-to-peak value measured) per 1000 rpm.

Note: This does not apply to V.R. motors as they have no rotor magnets.

1.7 HOLDING TORQUE: Holding torque is the peak resistance (at a specified current) to rotation of a gradually rotated shaft of an energized stepping motor. There are two 'n' such torque peaks (half positive, half negative) in a motor rated at n steps/revolution. The mode and applied current shall be specified. The torque shall be considered 'positive' when the rotor resists rotation of the shaft by an externally applied torque, and 'negative' when it requires the external torque to retard the shaft.

1.8 LOAD: Any external static or dynamic resistance to motion that is applied to the motor. The character of the load must be defined (e.g. Coulomb Friction, Viscous Friction, etc.).

1.9 LOAD ANGLE

1.9.1 STATIC LOAD ANGLE: Static Load Angle is the angle through which the rotor is displaced from its energized no load position by a given applied torque at a Command Pulse Rate of zero, at a specified current.

1.9.2 DYNAMIC LOAD ANGLE: The Dynamic Load Angle is the angle between the loaded and unloaded position of the rotor (at a given instant) under otherwise identical conditions at a specified command Pulse Rate & Phase Current.

1.10 MAXIMUM REVERSING COMMAND PULSE RATE: The maximum reversing pulse rate is the maximum pulse rate at which the unloaded step motor is able to reverse and remain in synchronism under the specified drive conditions.

1.11 MAXIMUM SLEW PULSE RATE: The maximum slew pulse rate is the maximum pulse rate at which the unloaded step motor can remain in synchronism under the specified drive conditions.

1.12 MECHANICAL HYSTERESIS: The angle (mechanical) between the unloaded quiescent point when moving CW and the unloaded quiescent point (of the same step position) when moving in the CCW direction.

1.13 MOUNTING SURFACE PERPENDICULARITY:

Mounting surface perpendicularity is the difference between the maximum reading and the minimum reading of the dial indicator probing the surface of a flat ground parallel surface metal plate (a minimum of 6 mm thick) mounted to the mounting surface of the motor. The motor shaft is held stationary and the motor with its test plate rotated about the shaft. The test plate shall have a surface finish of 1 micrometer (32 microinch) or better, and shall be parallel within 0.0025 mm (0.0001 inch) TIR over the surface. The indicator probe shall be applied at a diameter equal to the body diameter of the motor.

1.14 OVERSHOOT (TRANSIENT): The overshoot (transient) is the amount the shaft of the step motor rotates beyond the final position.

1.15 (MOTOR) PHASE: A motor phase is a set of electrically excited stator poles, consisting of one or more pairs of oppositely polarized poles. The magnetic polarity of these poles is sequentially reversed when the number of phases are even integers, in which case the electrical angle between phases is $180^\circ/\text{number of phases}$. When the number of phases are odd integers, the polarity of the poles does not reverse and the electrical angle between phases is $360^\circ/\text{number of phases}$.

NOTE: A bifilar wound set of poles constitutes one motor phase, not two, since the flux reverses in the pole albeit the pole has two windings and the current in each is unidirectional. The number of phases is not dependent on the number of windings, but rather on the electrical angle between poles.

1.16 POSITIONAL ERROR: Positional error (sometimes designated 'Absolute Accuracy') is the deviation from the theoretically correct angular position of any step position in a complete revolution. The zero position used in determining the theoretically correct angular position shall be the midpoint between the two extremes of position error. It is expressed as a % of the angle of the rated incremental angular motion per step, measured at no load, with rated current applied to the winding(s), the step sequence specified, and measured at 25° Celsius. In the 2-on step sequence the phase currents shall be balanced to within 1% of each other.

1.17 PULL-IN STEP RATE: The pull-in step rate is the maximum command pulse rate (constant) at which the energized step motor can accelerate an applied load from standstill to command pulse step rate, synchronously without missing steps.

Definitions (Continued)

1.18 PULL-IN TORQUE: The pull-in torque is the maximum positive coulomb friction torque at which an energized step motor will accelerate to command pulse step rate, and run in synchronism with the command pulse rate without losing steps, on application of a fixed specified inertial load and drive circuit conditions.

1.19 PULL-OUT STEP RATE: The pull-out step rate is the maximum command pulse rate (constant) at which the energized step motor can run in synchronism with the command pulse rate at a specified position coulomb friction load. Conditions of measurement shall exclude viscous friction and any other form of speed dependent torque.

1.20 PULL-OUT TORQUE: Pull-out torque is the maximum positive coulomb friction torque which can be applied to the rotating shaft of a step motor (already running in synchronism with the command pulse rate) at a given command pulse rate and conditions of drive circuit, without missing a step. Conditions of measurement shall exclude viscous friction and any other form of speed dependent torque.

1.21 RESOLUTION: The resolution is the reciprocal of the number of (full) steps per revolution of the motor shaft.

1.22 RESONANT STEP RATES: Resonant step rates are those step rates at which there are definitive peaks on the curve of velocity modulation amplitude vs step rate. The severity of a given resonant range is dependent on: (a) the velocity modulation amplitude and (b) the bandwidth of the step-rates in the range.

1.23 RESPONSE RANGE: Response range is the command pulse range over which the unloaded motor can accelerate to command pulse rate from standstill, decelerate from command pulse rate to standstill, or reverse direction (on command) without missing steps.

1.25 SETTling TIME: Settling time is the total time from the application of the command signal until the amplitude of the oscillatory motion of the rotor has diminished to 10% of the amplitude of the greatest oscillatory excursion in a given step.

1.26 SHAFT RUN-OUT: Shaft run-out is the difference between the maximum reading and the minimum reading of a dial indicator when located on the shaft surface. When the distance from the mounting surface is not specified, the extremity of the shaft shall be used by default. The motor frame is stationary during such measurement.

1.27 SLEW RANGE: Slew range is the range of command pulse rates over which the motor can remain unidirectionally in synchronism with the command pulse rate but cannot start, or reverse at a fixed command pulse rate without missing steps. The drive circuit conditions shall be specified.

1.28 STEP: A (full) "step" is the increment in angular position of the rotor between any two adjacent quiescent states when the phases are energized singly and in sequence. A step is always associated with two phases energized at all times or with one phase energized at all times. Alternate 1-on, 2-on energization is termed half-stepping.

1.29 STEP ANGLE (BASIC): Is the rated angular increment of rotor position, at no load between any two adjacent quiescent states when the phases are energized singly in sequence.

1.30 STEP ANGLE ERROR: (Sometimes designated "Incremental Step Accuracy".) This is the maximum + or - deviation from the rated incremental angular motion per step, for any adjacent steps in a complete revolution without reversing direction. It is expressed as a % of the angle of the rated incremental angular motion per step, measured at no load, with rated current applied to the winding(s), the step sequence specified, and measured at 25° Celsius. In the 2-on step sequence the phase currents shall be balanced to within 1% of each other. (Also see positional error.)

1.31 STEP POSITION: A step position is the static angular position which the shaft of an unloaded step motor assumes when it is energized without causing continuous rotation. The step sequence shall be specified.

1.32 STEP SEQUENCE: The sequence of excitation defined by the drive circuit, which when applied to the motor provides a repeatable cyclic pattern by which the windings are energized.

1.33 STEPPING MOTOR: A step motor is a polyphase synchronous inductor motor, the rotor of which rotates in discrete angular increments when the stator windings thereof are energized in a programmed manner either by appropriately timed DC pulses or by a polyphase alternating current. Rotation occurs because of the magnetic interaction between the rotor poles and the poles of the sequentially energized stator phases. The rotor has no electrical winding but rather salient or magnetized poles.

1.33.1 PERMANENT MAGNET (PM): A permanent magnet step motor utilizes a rotor which has permanently magnetized poles.

1.33.2 VARIABLE RELUCTANCE (VR) STEP MOTORS: A variable reluctance step motor utilizes a rotor which has pole salients (soft iron) without magnetic bias in the de-energized state.

1.33.3 HYBRID (HY): A hybrid step motor utilizes a permanent magnet to polarize soft iron pole pieces.

1.34 STEPPING RATE: The stepping rate is the number of step angles through which the step motor shaft rotates in a specified time.

1.37 THERMAL RESISTANCE: Thermal resistance is the opposition to the flow of heat in the materials of which the motor is constructed. It is expressed as degrees Celsius per watt. All measurements are taken after steady state conditions have been achieved.

1.37.1 THERMAL RESISTANCE (WINDING TO FRAME): This is the measured difference in temperature between the winding and the surface of the motor O.D. (midpoint) divided by the total electrical power (watts) input to the motor at the time and two temperature readings are taken.

Definitions (Continued)

1.37.2 THERMAL RESISTANCE (FRAME TO AIR): This is the same as 1.37.1 except that the temperature difference is between the winding and the surface of the motion O.D. midpoint and the air surrounding the motor. The air shall be still, the motor suspended in the air to prevent heat sink effect of bench surfaces, etc.

1.37.3 THERMAL RESISTANCE (FRAME TO HEAT SINK): This is the same as 1.37.1 except that the temperature differential is that which exists between motor frame and a heat sink. The heat sink shall be sufficiently large and sufficiently thick to be (effectively) an "infinite heat sink" to the motor in question.

1.38 THERMAL TIME CONSTANT: This is the time required for the winding temperature of a motor to reach 63% of its steady state temperature RISE with constant POWER applied to the motor. It is measured by allowing the motor to reach steady state temperature, and then disconnecting the electrical power input. The winding temperature is recorded as a function of time, zero time being the time at which the power source was disconnected. The time required to drop to 37% of the steady state temperature rise is the thermal time constant. It is usually expressed in seconds, but any unit of time may be used.

1.39 TORQUE GRADIENT: Torque gradient (sometimes called "stiffness torque") is the slope of the torque displacement curve at the no-load quiescent point.

1.40 TRANSLATOR LOGIC: Translator logic translates the input pulse train into the selected mode pattern to be applied to a step motor.

1.41 WINDING: A winding is an aggregate of magnet wire turns all on the poles of a given phase. Where there are two windings per phase, they may be connected in series or parallel. In the case of the series connection, the connection between the two windings of a phase (5-lead or 6-lead motors), the motor is referred to as a bifilar wound motor, but a "winding" consists of the magnet wire turns from the center tap to either end and not end to end.

1.42 WINDING INDUCTANCE: The winding inductance of a step motor winding varies both with rotor position and with excitation current. Measurements can also be affected by the rate of change of current; thus when a figure for inductance is given, the conditions under which the measurements were taken must be quoted. The following three types of inductance measurements each have their advantage and disadvantage. That of 1.42.1 is the simplest and fastest measurement to make, and requires the least equipment, but is least representative of actual operation conditions. The method of 1.42.3 on the other hand is the most representative of actual operating conditions, but is the most difficult and time-consuming of the methods and requires the most specialized equipment. The method of 1.42.2 is a compromise, perhaps leaning towards 1.42.3 as being representative of actual operating conditions.

1.42.1 INCREMENTAL UNENERGIZED WINDING INDUCTANCE:

An inductance bridge having a test frequency of 1 kHz is used for this test. The bridge voltage should be 1 v RMS applied to the motor. The inductance measurement should be made with the rotor locked in the "aligned" or "unaligned" position, with no DC current applied to any of the windings. The figure reported should state whether the "aligned" or "unaligned" position is used.

1.42.2 INCREMENTAL ENERGIZED WINDING INDUCTANCE:

This is the same as 1.42.1 except that the inductance measurement is made at some value of winding excitation. Unless otherwise stated, the winding excitation shall be that of rated current.

1.42.3 INCREMENTAL ENERGIZED WINDING INDUCTANCE BY CURRENT RISE TIME METHOD:

This measurement provides information from which incremental inductance can be calculated at any level of excitation up to the level of steady state energization. It is similar in nature to the inductance obtainable by paragraph 1.42.2 except that it does not suffer from the effects of the 1 kHz test frequency. Measurements are made with the rotor locked in the "aligned" and/or the "unaligned" position. As in 1.42.2 a constant DC voltage is applied to a phase winding. The voltage shall be of such magnitude that the steady state current is 10% higher than the highest value of current at which inductance information is desired. The rise of current with time is recorded (storage oscilloscope, digitized data on floppy disk, oscilloscope photograph, etc.) The derivative of the current vs. time curve (di/dt) is that used to compute the inductance at the value of excitation of interest from

$$L = \frac{V - I \cdot R}{di/dt}$$

Where:

- V = Applied voltage
- I = Current in amperes at which di/dt is measured
- R = Total circuit resistance (including current monitoring shunt if used) in ohms
- di/dt = Rate of change of current with voltage in amps/sec
- L = Inductance in henries

1.43 WINDING RESISTANCE: Winding resistance is the lead-to-lead (terminal-to-terminal) ohmic resistance measured with the windings at 25° Celsius. A winding is defined in paragraph 1.41. The method used for measurement of resistance shall be accurate to four significant figures, and the value reported to three significant figures, the minimum value rounded down, and the maximum value rounded up.

Distribution Coast-To-Coast and International

The Superior Electric brand is a global leader in the engineering, manufacturing, and marketing of precision motion and control products for industrial applications. All Superior motors and controls are backed by highly specialized engineers and service people who can help solve your production challenges. Superior Electric's capabilities and products have improved operations for companies around the world.

Through Danaher Motion's extensive authorized distributor network, Superior Electric products are available worldwide. These distributors provide convenient services by offering technical support, replacement parts, and literature, as well as an extensive inventory of models off-the-shelf for the fastest possible delivery.

Call Superior Electric customer service for ordering and application information or for the address of the nearest authorized distributor for Superior Electric products.

**Superior
Electric**

13500-J South Point Blvd. • Charlotte, NC 28273
TEL: 704-588-5693 • FAX: 704-588-5695

Danaher Motion Customer Support Center

13500-J South Point Blvd.
Charlotte, NC 28273
Tel: 704-588-5693
Fax: 704-588-5695
Support email: sales2@DanaherMotion.com
Web: www.DanaherMotion.com

In Europe

Danaher Motion GmbH & Co. KG
Robert-Bosch-Straße 10
64331 Weiterstadt, Germany
Tel: +49 (0) 6151-8796-10
Fax: +49 (0) 6151-8796-123
Internet: www.DanaherMotion.de



www.DanaherMotion.com